

Automatic on-line sample introduction for capillary electrophoresis connected via electrospray with condensation nucleation light scattering detection

Arkadi Ebber* and Mihkel Kaljurand

Institute of Chemistry, Tallinn Technical University, Akadeemia tee 15, 12618 Tallinn, Estonia

Received 8 May 2002, in revised form 14 August 2002

Abstract. Condensation nucleation light scattering detection (CNLSD) is considered to be a sensitive and universal detection method for capillary electrophoresis (CE). It may be connected to the separation capillary via electrospray (ES). Conventional sample introduction in a CE–ES–CNLSD system requires interruption of the electroosmotic flow (EOF) and ES by switching off the CE and ES high voltages.

We developed for CE–ES–CNLSD an automatic sample injection system, working in on-line mode, which can perform multiple sample introductions at the high voltage electrode without corrupting EOF and ES. The main part of the injection system is a pneumatically actuated sampler with a narrow-bore channel serving as an inlet reservoir for CE. In the channel the flow pulses of buffer and sample solutions can rapidly replace each other without bubbling or interrupting the electric current through the capillary. The injection device is totally computer controlled and it can perform hundreds of sample introductions according to any prescribed sequence with once established stable ES. The reproducibility of the set-up performance, measured from the peak areas, was 95–96%.

Key words: capillary electrophoresis, automatic injection, CNLSD.

INTRODUCTION

Capillary electrophoresis (CE) and capillary electrochromatography (CEC) are separation methods in which the eluent flows in the capillary due to the electroosmosis phenomenon when high electric voltage is applied across the capillary filled with buffer solution. For the detection of analytes in CE and CEC

* Corresponding author, ebber@chemnet.ee

in most cases the optical absorption method as a universal technique is utilized. However, because of a short optical pathway this method has a relatively low sensitivity and is actually not very universal. This motivates investigation of other detection principles with the aim to develop new universal and sensitive detectors. Among the post-column detection techniques there are some methods that are interfaced with the end of separation capillary via electrospray (ES) nebulizing the effluent into fine mist. For example, CE as well as CEC can be coupled through ES ionization to a mass spectrometer or to a condensation nucleation light scattering detector. The parameters of spraying have a strong effect on the reproducibility of detection and it is desirable to run analyses with a stable and uninterrupted process of converting the effluent to aerosol.

In the present study we focus our attention on CE hyphenated by ES with condensation nucleation light scattering detection (CNLSD). CNLSD is a universal detection method, which can be used in most types of column separations. Its principle of operation is based on the volatility of the eluent and a relatively lower volatility of analytes. The effluent from the separation column or capillary is nebulized by the sprayer into a gas stream, and from the aerosol droplets the volatile mobile phase is evaporated leaving behind dry particles of the analyte (Fig. 1). When nebulizing is performed by ES, the formed dry particles are electrically charged, and they should be neutralized in a charge neutralizer. Neutralized particles are swept by the carrier gas to the condenser, which is kept at a lower temperature and contains supersaturated vapour of a selected liquid. Desolvated particles serve as the nuclei for heterogeneous condensation and grow from the diameter as small as 3 nm to some micrometres. From the condenser the droplets are carried through the laser beam and the intensity of the scattered light is measured.

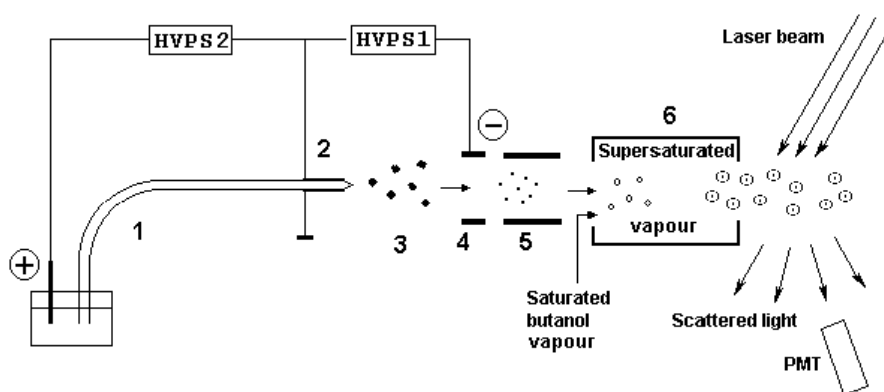

Fig. 1. Principle of CE-ES-CNLS. 1 – capillary, 2 – grounded gold coating, 3 – electro-spray (diameter of aerosol particles around 150 nm), 4 – ring-shaped counter electrode, 5 – neutralizer, 6 – condenser, PMT – photomultiplier, HVPS – high voltage power supply for electro-spray (1) and electrophoresis (2).

Compared to evaporative light scattering detection (ELSD), where light scattered from dry particles is measured, CNLSD is over 100 times more sensitive [1]. The CNLSD process is implemented in condensation particle counters (CPC) employed for determination of the concentration of particles in the air, but it has never been applied for detection purposes in column separations. Allen & Koropchak [2] first demonstrated CNLSD on a home-built system, employing HPLC and a gas flow nebulizer. In 1994 Lewis et al. [3] applied ES for nebulizing the effluent in size exclusion chromatography and static charge neutralizer to neutralize charged particles generated by ES. They used a commercial CPC for counting the number of particles in the gas flow coming from the spray chamber and demonstrated that the individual macromolecules with molecular mass greater than 10 000 Da (e.g. small protein) may serve as nuclei for condensation and thus be detected. Later CNLSD has been coupled to all the major column separation techniques [4–12].

Carrying out the experiments on a CE–ES–CNLSD system is rather inconvenient due to the cumbersome procedure of sample introduction into the separation capillary. According to the established sample injection procedure in CE, for sample introduction the high voltage across the capillary is switched off and the buffer at the inlet end of the capillary is replaced with the sample solution. Then the sample plug is introduced electrokinetically or hydrodynamically into the capillary, the sample solution is replaced with the buffer, and separation high voltage is again applied. But when ES is set up at the outlet end of the capillary simultaneously with disconnecting the electrophoretic high voltage, the voltage producing spray should also be switched off while the sample is introduced into the capillary. This leads to the interruption of the spraying process and, after the sample has been injected, ES must be quickly restored and accurately adjusted. Variations in the ES voltage have a strong effect on ES and, depending on voltage, the droplet shape at the end of the capillary may correspond to the different modes of ES operation (cone-jet mode, silver bullet, pulsating mode) [7]. So far the control of the ES voltage has been performed manually, observing through the microscope the shape of the spray cone at the capillary end and trying to adjust the same spray cone as it was before the spray interruption. It is evident that manually adjusted spray may vary from run to run and be an obstacle to obtaining strictly reproducible results. Moreover, the on/off switching of high voltages creates significant inconvenience in carrying out routine analyses.

Some injection procedures allowing sampling while CE high voltage is applied have been proposed. For example, Kuban and Karlberg with co-authors [13, 14] demonstrated that manipulations with buffer and sample flows at the capillary inlet (and thus also sample introduction) can be done without disturbing the separation voltage. A similar approach was proposed by Chen & Fang [15]. The falling drop method of Liu & Dasgupta [16] can also be applied for multiple sample introduction. For CEC, coupled via ES with mass spectrometry, an automated electroosmotic sample injection procedure was provided by Lane & Tucker [17]. In order to manipulate with buffer and sample flows, all the

proposed automated sampling systems needed that the inlet end of the capillary had to be grounded. This, in turn, creates complications in applying the necessary ES voltage at the other end of the capillary.

For practical work on a CE–ES–CNLSD system the exit end of the capillary (serving as a common electrode for CE and ES circuits) should be grounded, allowing independent adjustment of CE and ES high voltages. This means that all manipulations needed for sample introduction have to be performed at the inlet end of the capillary under high voltage without interruption of the electric current through the capillary. Injections under high voltage may be carried out using the pneumatically driven autosampler proposed by Kaljurand et al. [18]. It operates on the principle of rapid exchange of buffer with sample and sample with buffer in the narrow channel functioning as the inlet reservoir. All solutions are kept under high voltage and control occurs by compressed air through polyethylene tubing and pneumatic valves.

The purpose of this study was to develop an automated injection device for CE–ES–CNLSD enabling computer controlled on-line sample introductions without interrupting ES and the separation process and providing an opportunity to run a sequence of analyses at exactly the same conditions.

EXPERIMENTAL

The entire experimental CE–ES–CNLSD set-up and its main component, a sampler, are depicted in Fig. 2. The sampler (Fig. 2A) was fabricated from a $25 \times 35 \times 55$ mm Plexyglas block into which the inlet narrow-bore channel, serving as the inlet reservoir for CE, was drilled. One end of the inlet channel was connected to the waste reservoir. To the other end three side channels were connected at right angles. For simplicity, only two side channels and two diaphragm valves are shown in Fig. 2A, but the sampler may have more side channels. Each side channel delivers one liquid through the diaphragm valve into the sampler inlet channel. A diaphragm valve has a thin Teflon film (diaphragm) actuated by compressed air. When sufficient air pressure is applied to the Teflon film, the flow of the liquid through the valve is closed. For sampler operation the buffer and sampler solutions were kept at pressure P1 of about 0.6 bar. For closing the diaphragm valves air pressure P2 was about 0.9 bar. But when the air pressure on the diaphragm is released, the valve opens and a thin layer of the buffer or sample solution can flow through the valve into the inlet channel. For illustration, the diaphragm valve 3 is in an open position, and valve 4 is closed in Fig. 2A. Opening the buffer valve for a brief period of time (about 0.15 s) allows filling the inlet channel with the buffer, and opening a sample valve for a short time rapidly replaces the buffer in the inlet channel with sample solution. During 0.15 s approximately 0.2 mL of liquid flowed to the waste through the inlet channel, which had a volume of 0.03 mL (I.D. 1 mm and length 30 mm).

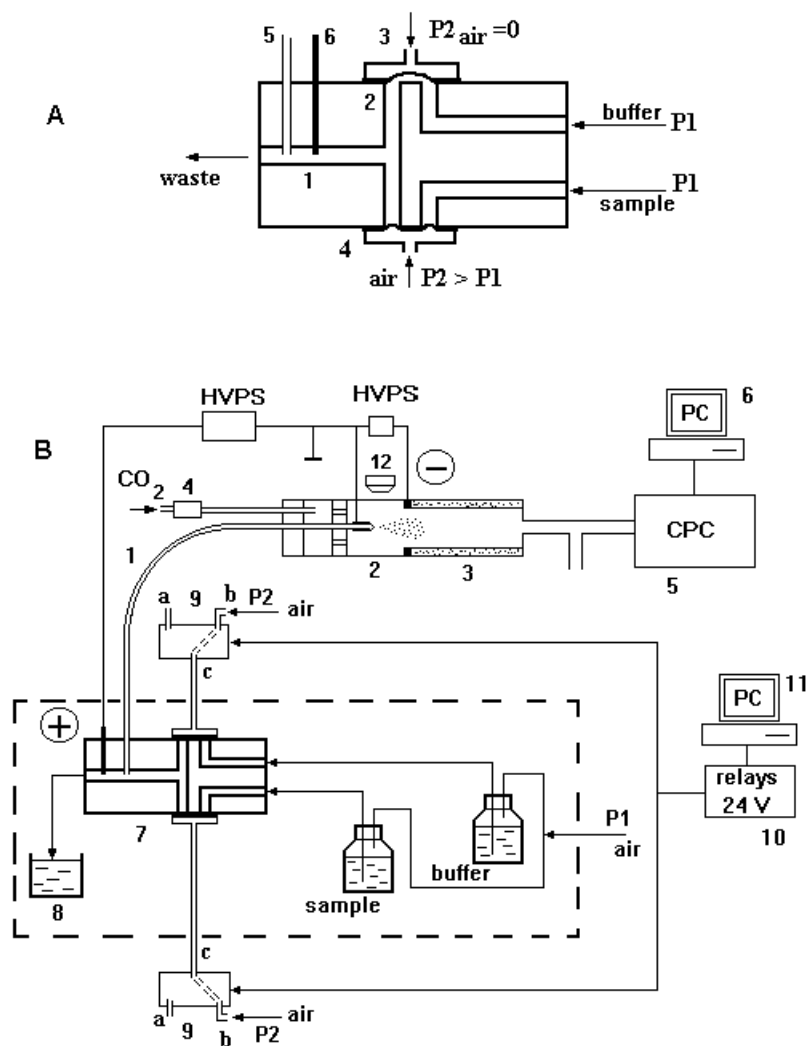

Fig. 2. Schematic of the sampler (A) and experimental CE-ES-CNLS set-up with automatic on-line sample injection (B). Dashed rectangle is Plexiglas safety box, the parts of the set-up in the box are exposed to high voltage.

A. Sampler: 1 – inlet channel, 2 – side channel, 3, 4 – diaphragm valves (valve 3 is open and valve 4 is closed), 5 – capillary, 6 – electrode.

B. Set-up: 1 – capillary, 2 – spray chamber, 3 – neutralizer, 4 – carrier gas (CO₂) flow controller, 5 – condensation particle counter, 6 – PC for signal recording, 7 – sampler, 8 – waste, 9 – pneumatic valves with three ports (a, b, c), 10 – solenoid valves controller, 11 – PC for controlling injections, 12 – microscope.

The opening and closing of diaphragm valves are controlled by the solenoid valves 9 (Fig. 2B), which are isolated from the high voltage applied to the electrode (and, thereby, to the diaphragm valve) by the polyethylene tubing. The solenoid valves, driven by 24 V DC, have two positions. When the solenoid

valve is in off position, ports *b* and *c* are connected and air pressure P2 closes the diaphragm valve. But when the solenoid valve is switched on, port *c* is connected through port *a* with the atmosphere, releasing pressure on the Teflon diaphragm. Actually for replacing one liquid with another in the inlet channel one needs just to apply 24 V and ~0.15 s long voltage pulse on the corresponding solenoid.

The sampling procedure is as follows. Switching the buffer line solenoid valve (upper valve 9 in Fig. 2B) on for a brief period by the voltage pulse fills the sampler's inlet channel with the buffer. Then CE and ES high voltages are switched on and adjusted (in our experiments the direction of the electroosmotic flow was from the anode to the grounded cathode and sampling took place at the anodic end of the capillary). Opening the sample line solenoid (lower valve 9) for a short time replaces the buffer in the inlet channel with the sample, and the electrokinetic injection begins at CE analysis voltage. After a few seconds have elapsed the sample solution is again replaced with the buffer by applying the voltage pulse on the upper solenoid valve, and the electrophoretic run starts.

When the run takes a long time, the buffer in the inlet channel should be refreshed periodically (with an interval of a few minutes). Otherwise, sample molecules from the side channel may diffuse into the buffer and reach the injection area. Another reason for refreshing the buffer in the inlet channel is that a fraction of the buffer from the narrow inlet channel may be consumed and the inlet channel needs refilling.

Our set-up can work in manual and computer controlled modes. In the manual mode, which is very flexible and used for testing and preliminary searching the best separation parameters, each solenoid valve can be switched on just by pushing the button. In the computer controlled mode the injection pattern should be exactly prescribed (i.e. when and which sample/buffer to inject, how many times, intervals between injections, how to flush the inlet channel between sample injections, and so on). Programs for controlling the set-up by computer were written in C++ and allowed via ADC (Keithley Instruments) to send 5 V signals to the relays, which switched on the power for the solenoid valves (Burkert, Basel, Switzerland).

The detecting part of the set-up was built mostly from commercially available components. Electropherograph ISCO CV⁴ was used as a high voltage source for CE separation and as a tool for monitoring the electric current through the capillary. Electrophoretic runs were carried out at 18 kV and the electric current was around 8 μ A. For ES generation a high voltage supply unit from Bertran Associates Inc. (USA) was used. Depending on the electric field producing the spray, droplets of different shapes could be formed at the capillary end. When the distance between the capillary tip and the counter electrode was approximately 10 mm, the voltage of about 3 kV was needed to obtain the desired "silver bullet" mode spray. To neutralize positively charged particles produced by the ES, the cylindrical neutralizer P-2021 (NRD Inc., Grand Island, NY) was placed immediately after the spray chamber and a negative high voltage was applied directly to the neutralizer. The neutralizer contained radioactive polonium-210, an α -emitter with an activity of 10 mCi. The decay of Po-210 creates a weak bipolar plasma, which neutralizes the charged particles.

For electrophoresis an uncoated fused silica capillary with I.D. 50 μm and O.D. 150 μm was used. To create electrical contact for grounding, the polyimide coating from the outlet end of the capillary was removed by burning and the bare tip of the capillary (approximately 3 cm) was covered with gold paint (OG 805 Premium Gold, Duncan Enterprises, Fresno, CA). The painted end of the capillary was placed in a 7 cm long grounded stainless steel tube with I.D. 0.2 mm, which was also used as a capillary support.

The spray chamber (50 mm long transparent glass tube with I.D. 15 mm) was placed under an optical microscope in order to observe the capillary tip when the spray voltage was adjusted.

The carrier gas CO_2 with a flow rate 1 L/min was filtered through a HEPA cartridge and fed to the spray chamber via a mass flow controller. From the neutralizer the dry and neutral particles were carried into an Ultrafine Condensation Particle Counter 3025A (TSI, St. Paul, MN). Since the CPC pump could draw only 300 mL/min of gas, the carrier gas flow after the neutralizer was splitted. The CPC signal (number of particles in 1 cm^3) was recorded at a frequency of 10 Hz by another computer, which also controlled the operational parameters of CPC (e.g. kept the condenser temperature at 10°C).

The parts of the injection system that had electric contact with the high voltage electrode (viz. the sampler, the buffer, sample and waste reservoirs) were placed in a safety Plexiglas box. The buffer and sample solutions were kept in 100 mL bottles with screw caps, so that also vessels with larger or smaller volumes could be used. In order to get rid of air bubbles, the buffer and sample solutions were sonicated and kept in bottles under helium pressure.

Chemicals. As the volatile electrophoretic buffer, 10 mM aqueous solution of ammonium acetate was utilized. The rinsing of the capillary was carried out with 1 M aqueous ammonium hydroxide. Terbutaline (actually terbutaline hemisulphate salt) was from Sigma (St. Louis, MS), sodium and potassium chlorides from Aldrich (Milwaukee, WI). After distillation and deionization the water had a resistivity of 18 $\text{M}\Omega/\text{cm}$.

RESULTS AND DISCUSSION

When the experimental set-up was assembled it started to work without major problems. After the electrophoretic high voltage and ES voltage were adjusted, we could perform sample introductions at the anodic end of the capillary from any of the two sample bottles connected to the sampler or flush the sampler inlet channel with buffer without corrupting the ES or the separation process and without bubble formation. In computer controlled mode any desired injection procedure could be accomplished very precisely. For example, Fig. 3 shows the electropherogram of four automatic injections of aqueous solution of *trans*-resveratrol. Figure 4 demonstrates the sequence of injections with different injection times. We observed that when the analyte was sprayed at the capillary outlet end, the spray droplet at the

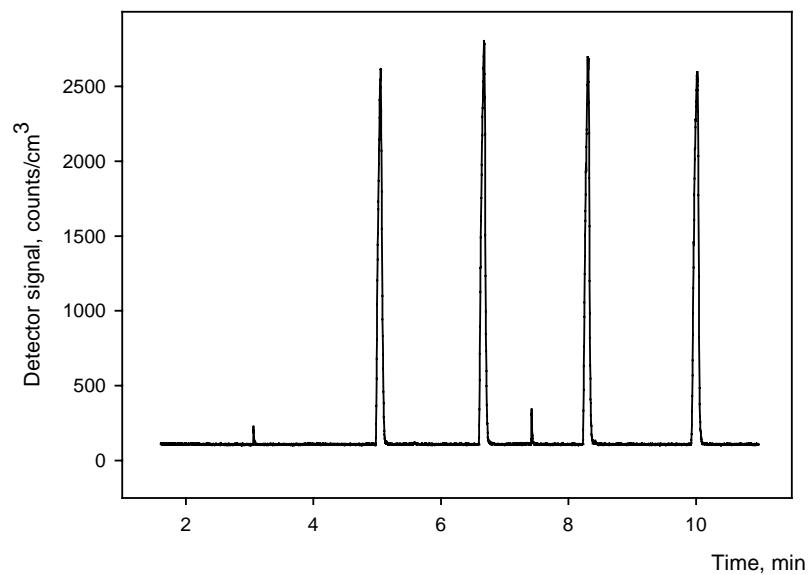

Fig. 3. Electropherogram of four injections of *trans*-resveratrol solution (3 ppm in buffer), performed under computer control. Injection time 3 s.

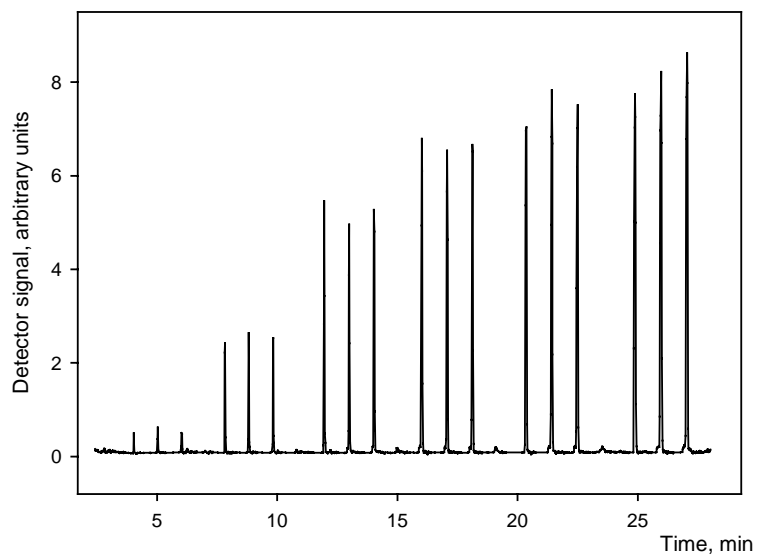

Fig. 4. Electropherogram of consecutive injections of terbutaline at different injection times: 1, 2, 3, 4, 5, and 6 s. Sample of 4 ppm in the buffer was injected three times for each injection period.

capillary exit became small, but then restored again. For achieving high reproducibility some optimal values of the parameters should be adjusted. For example, for short injection times (around 1 s) the reproducibility was low and for long injection periods (over 6 s) the detector response was not linear. Analyte concentration and separation high voltage also influenced the reproducibility. To test the reproducibility of the performance of the automatic injection device and to compare it with the manual injection procedure, the sequences of terbutaline solution injections and aqueous NaCl injections were carried out at optimal parameters (Fig. 5). For 13 consecutive injections of terbutaline solution in the ammonium acetate buffer the relative standard deviation (RSD) calculated from

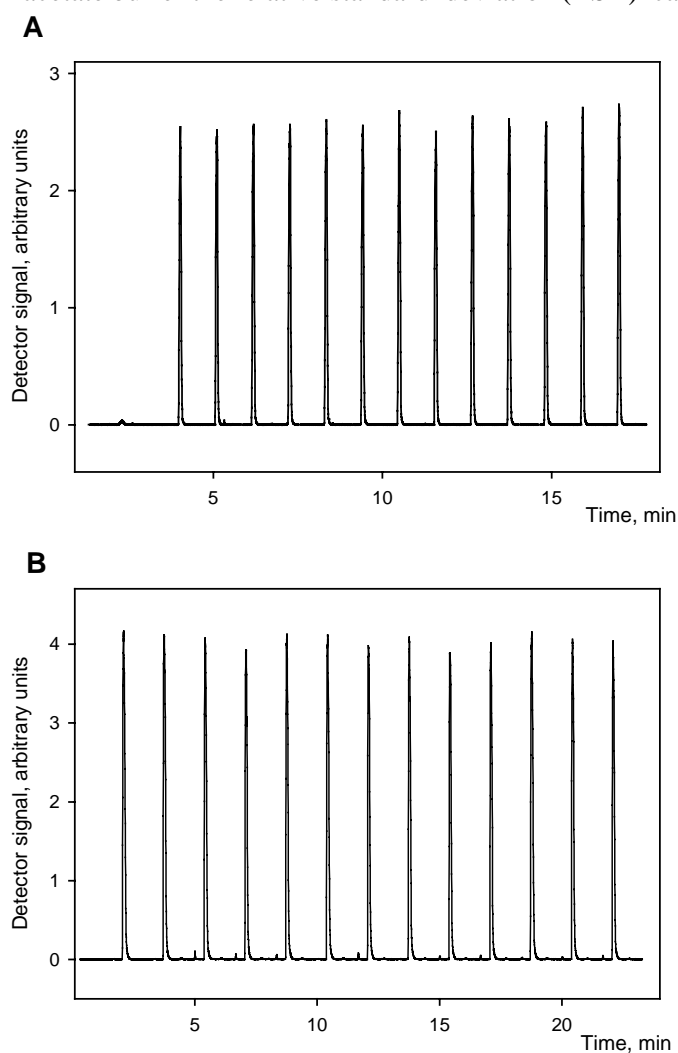

Fig. 5. Electropherograms of two sample introduction sequences, demonstrating the reproducibility of the CE-ES-CNLS system in the absence of stacking (A) and when stacking occurs (B).

A. Terbutaline, 4 ppm solution in running buffer; B. NaCl, 1 ppm solution in water.

the peak areas was 4%. The analogous procedure for NaCl solution in water led to the value of 6%. Our numerous data on manual injection of different samples showed marked variations of peak areas in parallel runs on CE-ES-CNLS (up to 30%), and allowed us to estimate the average RSD for manual injections at 10–15%. It was also noticed in many preliminary runs that when the stacking phenomenon was involved, the reproducibility was not so high as in the case when the buffer was used as a solvent. Stacking, however, allows concentration of analytes during the injection and reaching lower detection limits. Figure 6 demonstrates impressively the stacking effect when the sampler injects under exactly the same conditions terbutaline solutions of the same concentrations, but dissolved in buffer and in water. An advanced feature of the proposed sampler is the strictly fixed position of the electrode and the capillary tip in the sampler inlet channel. Figure 7 illustrates the detection of Na⁺ and K⁺ ions in water at 1 ppb concentration level. This Figure demonstrates that in the presence of stacking the detection limits of our system may be estimated to be in the sub-ppb region.

Performing on-line multiple injections from various vessels the sampler enables to easily compare samples that differ in some parameter (e.g. for quantification, the external standard solution may be injected). Such comparison is unattainable when the traditional sampling procedure with the interruption of ES is utilized.

On-line sample injection at a high voltage is needed in all cases the grounded post-column detector has electrical contact with the capillary end. It seems to be especially important when CE or CEC is hyphenated via ES with mass spectrometry.

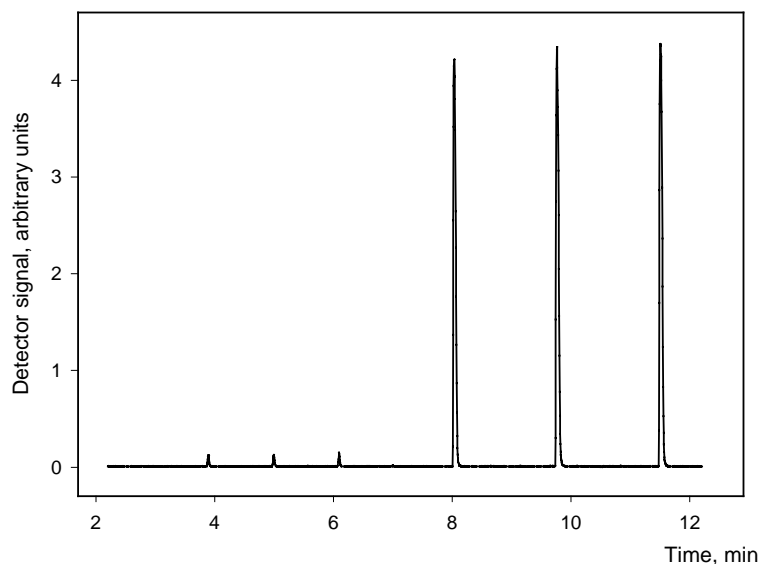

Fig. 6. Electropherogram of on-line injections of 0.5 ppm terbutaline dissolved in buffer (three small peaks) and in water (high peaks).

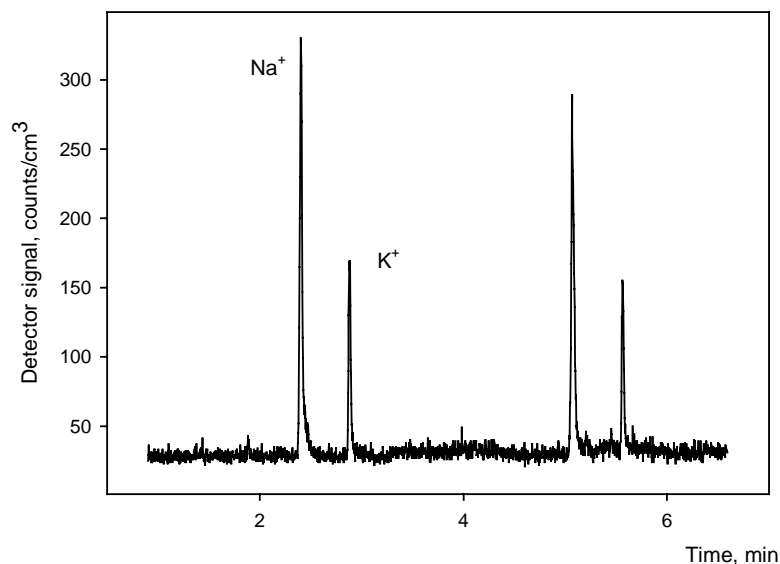

Fig. 7. Electrophrogram of two on-line injections of NaCl and KCl dissolved in water, concentration of each salt is 1 ppb. Injection period is 4 s at 18 kV.

CONCLUSIONS

This paper describes an automatic injection device for CE-ES-CNLS D developed by the authors that can perform on-line sample introductions in the separation capillary at a high voltage without interrupting the electroosmotic flow and the ES. The main component of the injection system is a sampler with pneumatically actuated diaphragm valves, which can operate under computer control. The injection system can perform highly reproducible injections at any time, from any connected vessel, and according to any prescribed injection pattern. Reproducibility of the performance measured at optimal parameters from the peak areas in an injection sequence performed on-line reached 96%. CNLS D is a really universal method allowing detection of organic compounds as well as inorganic salts.

Results of this study may serve as basis for practical implementation of CNLS D. Automatic injection may also be used for monitoring chemical reactions or for performing complicated experiments, where fast and precisely timed injections are needed (e.g. pseudorandom injections used in the multiplex method). The use of the on-line sample introduction at the high voltage inlet end of the capillary when CE or CEC is coupled with ES ionization mass spectrometry seems to be especially promising.

The drawbacks of the described injection system are the large volumes of the buffer/sample solutions (5–10 mL) necessary and the limited number of sample lines (each line includes a sample reservoir, solenoid and diaphragm valves, a relay, and one side channel in the sampler body) connected to the sampler.

ACKNOWLEDGEMENTS

The authors acknowledge the National Research Council (USA) for financing the twinning grant enabling to carry out experiments with our injection device in Southern Illinois University at Carbondale. We are grateful to Prof. Koropchak for helpful discussions and for allowing us to use his laboratory instrumentation.

REFERENCES

1. Koropchak, J. A., Heenan, C. L. & Allen, L. B. Direct comparison of evaporative light-scattering and condensation nucleation light-scattering detection for liquid chromatography. *J. Chromatogr. A*, 1996, **736**, 11–19.
2. Allen, L. B. & Koropchak, J. A. Condensation nucleation light scattering: a new approach to development of high-sensitivity, universal detectors for separations. *Anal. Chem.*, 1993, **65**, 841–844.
3. Lewis, K. C., Dohmeier, D. M., Jorgenson, J. W., Kaufman, S. L., Zarrin, F. & Dorman, F. D. Electrospray–condensation particle counter: a molecule-counting LC detector for macromolecules. *Anal. Chem.*, 1994, **66**, 2285–2292.
4. Allen, L. B., Koropchak, J. A. & Szostek, B. Condensation nucleation light scattering detection for conventional reversed-phase liquid chromatography. *Anal. Chem.*, 1995, **67**, 659–666.
5. Lewis, K. C., Jorgenson, J. W. & Kaufman, S. L. Capillary zone electrophoresis with electrospray condensation particle counting detection. *J. Cap. Elec.*, 1996, **3**, 229–235.
6. Szostek, B. & Koropchak, J. A. Condensation nucleation light scattering detection for capillary electrophoresis. *Anal. Chem.*, 1996, **68**, 2744–2752.
7. Szostek, B., Zajac, J. & Koropchak, J. A. Coupling condensation nucleation light scattering detection with capillary electrophoresis using electrospray. *Anal. Chem.*, 1997, **69**, 2955–2962.
8. Lewis, K. C., Jorgenson, J. W., Kaufman, S. L. & Skogen, J. W. Capillary reverse-phase high-performance liquid chromatography (HPLC) with electrospray condensation particle counting detection. *J. Microcolumn Sep.*, 1998, **10**(6), 467–471.
9. Sadain, S. K. & Koropchak, J. A. Condensation nucleation light scattering detection for biogenic amines separated by ion-exchange chromatography. *J. Chromatogr. A*, 1999, **844**, 111–118.
10. Guo, W., Koropchak, J. A. & Yan, C. Sensitive, universal detection for capillary electrochromatography using condensation nucleation light scattering detection. *J. Chromatogr. A*, 1999, **849**, 587–597.
11. Sadain, S. K. & Koropchak, J. A. Condensation nucleation light scattering detection (CNLSD) for ion chromatography. *J. Liq. Chromatogr. & Relat. Technol.*, 1999, **22**, 799–811.
12. Koropchak, J. A., Sadain, S., Yang, X., Magnusson, L.-E., Heybroek, M., Anisimov, M. & Kaufman, S. L. Nanoparticle detection technology for chemical analysis. *Anal. Chem.*, 1999, **71**, 386A–394A.
13. Kuban, P. & Karlberg, B. On-line monitoring of kraft pulping liquors with a valveless flow injection–capillary electrophoresis system. *Anal. Chim. Acta*, 2000, **404**, 19–28.
14. Kuban, P., Berg, M., Garcia, C. & Karlberg, B. On-line flow sample stacking in a flow injection analysis–capillary electrophoresis system: 2000-fold enhancement of detection sensitivity for priority phenol pollutants. *J. Chromatogr. A*, 2001, **912**, 163–170.
15. Chen, H.-W. & Fang, Z.-L. Combination of flow injection with capillary electrophoresis. Part 3. On-line sorption column preconcentration capillary electrophoresis system. *Anal. Chim. Acta*, 1997, **355**, 135–143.

16. Liu, H. & Dasgupta, P. K. A falling drop for sample injection in capillary zone electrophoresis. *Anal. Chem.*, 1997, **69**, 1211–1216.
17. Lane, S. J. & Tucker, M. G. An automated electro-osmotic sample introduction/separation interface for automated electro-osmotic flow-injection mass spectrometry and capillary electrochromatography mass spectrometry. *Rapid Commun. Mass Spectrom.*, 1998, **12**, 947–954.
18. Kaljurand, M., Ebber, A. & Sömer, T. An automatic sampling device for capillary zone electrophoresis. *J. High Resol. Chromatogr.*, 1995, **18**, 263–265.

Proovi automaatne sisestamine katkematult töötava tuumakondensatsiooni valgushajumisdetektoriga kapillaarelektroforeesi

Arkadi Ebber ja Mihkel Kaljurand

Proovi sisestamine pidevalt toimuvasse kapillaarelektroforeesi (*on-line* sisestamine) on üldjuhul teostatav, kui kapillaari sisendots on maandatud ja detekteerimine toimub kõrgepinge all olevas kapillaariotsas. Kui detekteerimine peab toimuma kapillaari maandatud väljundotsas, saab proovi sisestada ainult kõrgepinge all olevast sisendotsast ning proovi sisestamisel ei tohi elektrivool läbi kapillaari katkeda. Käesoleva uurimuse tarbeks ehitati elektroforeetiline süsteem, kus kapillaari maandatud väljundots oli elektropihustamise kaudu ühendatud tuumakondensatsiooni valgushajumisdetektoriga ja proovi sisestamiseks kasutati autorite poolt varem välja töötatud pneumaatilist sisendseadet. Selline süsteem, mis oli ka arvutiga juhitav, võimaldas automaatselt sisestada proove kahest sisendseadmega ühendatud anumast suvalise etteantud programmi järgi. Optimaalsetes tingimustes oli paralleelkatsete reprodutseeritavus 96%.