

## Self-consistent acidity and basicity scales in nonaqueous solvents

Ivo Leito<sup>\*</sup>, Ivari Kaljurand, Toomas Rodima, Agnes Kütt, Aino Pihl,  
Eva-Ingrid Rõõm, Lilli Sooväli, Vahur Mäemets, Viljar Pihl,  
and Ilmar A. Koppel

Institute of Chemical Physics, University of Tartu, Jakobi 2, 51014 Tartu, Estonia

Received 10 January 2005, in revised form 17 March 2005

**Abstract.** A method for creating self-consistent acidity and basicity scales in nonaqueous solvents is presented and the current progress in applying such scales to different solvents is reviewed. The method is based on UV–Vis spectrophotometric titration of a mixture of two acids (or two bases) with a non-absorbing base (acid). From the titration data the relative acidity (relative basicity) of the two compounds – the difference of their  $pK_a$  values ( $\Delta pK_a$ ) – is obtained. When a large set of compounds that have different acid (base) strengths is available and  $\Delta pK_a$  measurements are carried out in such a way that each compound is measured against several other compounds, a self-consistent acidity (basicity) scale can be built. The relative acidities (basicities) of the compounds included in the scale can be determined at very high accuracy: many of the error sources, most importantly moisture and impurities in the solvent and in the compounds, influence both compounds in a similar way and at least partially cancel out. Using this method, self-consistent acidity scales have been created in heptane and acetonitrile and self-consistent basicity scales have been developed in acetonitrile and THF. These scales are discussed and future plans are outlined.

**Key words:** acidity scales, basicity scales,  $pK_a$  values, dissociation constants, nonaqueous solvents.

### INTRODUCTION

Acid–base behaviour of molecules is very important in chemistry [1] and significant effort has been devoted to studies of acid–base equilibria in water [2], in nonaqueous media [2, 3], and in the gas phase [4]. While in water the acidity and basicity data ( $pK_a$  values) can generally be regarded as reliable and ample,

---

<sup>\*</sup> Corresponding author, [ivo.leito@ut.ee](mailto:ivo.leito@ut.ee)

there are, currently, considerably fewer comparable values in nonaqueous media [2]; indeed, nonaqueous  $pK_a$  data are often scarce and the results reported by different authors are sometimes significantly inconsistent.

One might think that the lower the polarity of the medium, the simpler the interactions between the molecules; in fact, the opposite holds. In a somewhat simplified form the consecutive equilibria that occur in solution when a neutral acid  $HA^{z+1}$  ( $z = -1$ ) reacts with a solvent  $S$  to release a proton can be represented as follows:

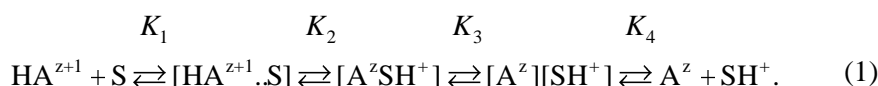

In this case,  $A^z$  is the conjugate anionic base of  $HA^{z+1}$ . The overall product of these consecutive equilibrium constants,  $K_1 \cdot K_2 \cdot K_3 \cdot K_4 = K_a$  (or its negative logarithm  $pK_a$ ) expresses the acid strength of the compound. The acid dissociation constant  $K_a$  of equilibrium in Eq. 1 can be expressed as:

$$K_a = \frac{a(SH^+) \cdot a(A^z)}{a(HA^{z+1})}, \quad (2)$$

$$pK_a = -\log \frac{a(SH^+) \cdot a(A^z)}{a(HA^{z+1})}. \quad (3)$$

The simple overall process described by  $K_a$  (Eq. 2) can be directly studied only in water and nonaqueous solvents of high polarity such as DMSO or acetonitrile. In less polar solvents, which have a low dielectric constant and hence have poor ion-pair dissociating and ion-solvating abilities, the concentration of free ions is very low, as in the case of THF or even negligible, as in the case of heptane. Therefore one has to take into consideration both ion-ion association and ion-neutral association. The simplest forms of ion-ion association are represented by the equilibria leading to the formation of contact ( $[A^z SH^+]$ ) and solvent-separated  $[A^z][SH^+]$  ion pairs. If the concentration of the ionic species in the solution is high, also ion triplets and higher aggregates may form. The ion-neutral association processes are known as homo- and heteroconjugation processes [5] (Eqs. 4 and 5, respectively,  $z = -1, 0$ ).

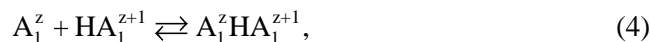

In solvents of low polarity these processes occur to a lower extent compared to ion-pairing and at low concentration these conjugation processes between ions and neutrals can be neglected because most of the ions present in the solution are ion-paired. However, in dipolar aprotic solvents, which have a high dielectric

constant and no hydrogen bond donor ability, for example acetonitrile, ion–neutral association processes are very important: the poorly solvated anions are stabilized by hydrogen bonding with neutral acids.

Hence in terms of ion–neutral association and ion-pairing the following generalizations can be made:

If the solvent is able to solvate both anions and cations and has dielectric constant  $D \geq 40$  (water, formamide), only the equilibrium described by the overall constant  $K_a$  (Eq. 2) is important [6] and Eq. 1 simplifies to give the Brønsted scheme of interaction:



In solvents with a high donicity number ( $DN$ ) and  $D \geq 30$  but a low acceptor number ( $AN$ ) (dipolar aprotic solvents) the acid–base interaction generally proceeds to the formation of free ions. Some ion-pairing may also occur depending on the solvent. Due to the lack of solvation of anions, the latter tend to undergo homo- and heteroconjugation reactions in these media.

In solvents with  $D = 15\text{--}30$  (acetone, benzonitrile), a very complex mixture is usually present, involving various amounts of all the species described in Eq. 1, as well as different higher associates.

In solvents with a high  $DN$  but a low  $D$  (pyridine, cyclohexanone) the interaction generally stops at the stage of solvent separated ion pairs, with the cation strongly solvated while the solvation of the anion is weaker.

In solvents with a low  $D$  that also lack the ability to solvate ions (hydrocarbons, halohydrocarbons) the interaction does not go beyond the initial hydrogen bond or contact ion pair formation. The extent of the interaction is dependent on the medium and the HA and B involved (their strength, charge delocalization in the respective ions, etc.). In such solvents numerous other processes, not represented by Eq. 1, can take place. Ions and neutrals can form aggregates of higher order, and ion tetra- and hexamers can be formed in addition to the ion pairs [5]. In alkanes – extremely nonpolar solvents – ions are generally present as large aggregates.

The interplay of all the processes mentioned above leads to a very complex and hard-to-model system in low-polarity solvents. This complexity generally increases as the polarity of the medium decreases; that is, the lower the solvating ability of the solvent molecules, the more the ions tend to interact with each other and other neutrals in the solution. Although in practice the experimental conditions can usually be adjusted so that significant simplifications can be made to the mathematical descriptions (low concentrations of species, large-size ions with delocalized charge, etc., see below), the experiments and the corresponding data treatment are still very demanding.

Just as the interactions of acids and bases and their ionized forms in the solution become more and more complex as the polarity and solvating power of the medium decrease, the influence of impurities on the solvent also becomes

more pronounced. The most important of these is the omnipresent water, which stabilizes polar species – especially ions – in nonpolar solvents and hence shifts the acid–base equilibria leading to erroneous results in the measurements of acidity or basicity. Traces of water are present in all solvents, even in solvents of as low polarity as alkanes. Also of importance are the traces of acidic and basic impurities found in many solvents (acetonitrile, haloalkanes, etc.). Yet another very annoying impurity in solvents is the dissolved oxygen, which does not have much influence if working in the acidic range, but can be detrimental to measurements carried out under strongly basic conditions. For example, studies of the superbases and carbanions are often very sensitive to oxidation. The traces of peroxides that are found in some solvents (most notably ethers, such as THF) are just as harmful as oxygen itself.

In spite of the problems outlined above, studying acid–base equilibria in nonaqueous media is a rewarding endeavour. Acidity and basicity research in solvents of low polarity is very valuable for several reasons:

- allows investigating the behaviour of compounds in an environment that is less influential on their certain physical and chemical properties than are the polar solvents,
- provides a possibility of studying systems of extraordinarily high or low acidity and basicity,
- is a tool for mimicing real processes in organic synthesis and chemical technology, many of which are carried out in nonpolar media, and
- helps to better understand the nature of solvent–solute interaction and the influence of media on chemical properties of various families of compounds.

At first sight it may seem that large collections of acidity and basicity data have already been published, also for nonaqueous media. For example, in the Palm Tables [2] – perhaps the most voluminous collection of acidity and basicity data available – more than 50 individual solvents are listed, ranging from the highly polar water and alcohols to ethers and halohydrocarbons. On closer inspection, however, one finds that there are enormous gaps in our knowledge: for most of these solvents the data are fragmentary at best. If we examine the largest available collections of acidity and basicity data in nonaqueous solvents (see references 2, 3, 7, 8), it becomes obvious that the data are more or less representative for less than 10 solvents. And even in these media, there are (or were up to quite recent time, see the sections below) considerable inconsistencies between the data from different groups. For example, for well-known compounds in acetonitrile: the  $pK_a$  values for 2,4-dinitrophenol vary from 16.0 to 18.4 [9]; for 4-toluenesulphonic acid from 8.01 to 8.73 [9, 10]; for 4-aminopyridine from 17.00 to 18.38 [11]; for pyridine from 12.33 to 12.60 [11]; for triethylamine from 17.24 to 18.46 [11]. For most of these compounds the uncertainty range is wider than an order of magnitude, yet all these compounds are stable and have  $pK_a$  values in a very convenient acidity/basicity range for study. In the case of unstable and/or extremely acidic/basic compounds the discrepancies are sometimes several orders of magnitude.

In this paper we give an overview of the results of our ongoing work in establishing and extending reliable self-consistent acidity and basicity scales in nonaqueous media. The earlier studies on the determination of acidity and basicity constants in nonaqueous media started in our group in the 1970s and the topic became a central theme in our group by the mid-1990s with the development of new measurement methods by our group and advancement of the experimental techniques.

On a more general note, our work is aimed at creating reliable acidity and basicity scales in different media with as diverse properties as possible. When sufficient acidity and basicity data for different families of acids and bases are available, deeper understanding can be gained on the influence of the solvent on the acid–base properties of molecules.

It is important to note that the acidity and basicity research in nonaqueous media is closely connected to the acidity and basicity measurements in the reference medium – the gas phase. For the rest of this review, the gas-phase measurements will also be referred to where appropriate.

## OUTLINE OF THE MEASUREMENT METHOD AND EXPERIMENTAL CONDITIONS

In order to minimize the problems outlined above, such as aggregation, solvent impurities, etc., we use the highest available grades of solvents and additionally purify them as necessary. The work was carried out in an inert gas glovebox to minimize the influence of traces of moisture and oxygen. We have introduced an original UV–Vis spectrophotometric measurement method for studying acid–base equilibria in solutions. In this method proton distribution equilibrium between two compounds  $\text{HA}_1^{z+1}$  and  $\text{HA}_2^{z+1}$  is studied:

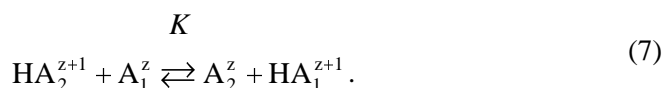

The negative logarithm of the equilibrium constant  $K$  measures the difference of acidities of the acids  $\text{HA}_1^{z+1}$  and  $\text{HA}_2^{z+1}$  in specific conditions:

$$\Delta\text{p}K_a = \text{p}K_a(\text{HA}_2^{z+1}) - \text{p}K_a(\text{HA}_1^{z+1}) = -\log K = \log \frac{a(\text{A}_1^z) \cdot a(\text{HA}_2^{z+1})}{a(\text{HA}_1^{z+1}) \cdot a(\text{A}_2^z)}. \quad (8)$$

This method is unique in that for the calculation of  $K$  all the necessary data are obtained from UV–Vis spectra recorded on the titration of the mixture of  $\text{HA}_1^{z+1}$  and  $\text{HA}_2^{z+1}$  with strong base and acid. There is no need for the determination of  $a(\text{H}^+)$ , which is a complicated task in nonaqueous media. By having a large set of compounds with various acid strengths and carrying out  $\Delta\text{p}K_a$  measurements so that each compound is measured against at least two other compounds, a self-

consistent acidity scale can be built. The relative acidities of the compounds belonging to the scale are determined by very high accuracy and many of the error sources (most importantly moisture and impurities in the solvent and in the compounds) that influence both compounds in a similar way at least partially cancel out. The drawback of this method is that only relative acidities are obtained and for absolute acidities the scale has to be anchored to the compound with known absolute acidity ( $pK_a$ ) value.

Using this method we have succeeded in building self-consistent acidity or basicity scales in several media. These are discussed in the subsequent sections. Additional details on the experimental techniques can be found in the following sections and in [11–15].

### ION-PAIR ACIDITY SCALE IN HEPTANE

An exciting and practically unexplored field of acid–base studies is measurements in very nonpolar media, particularly in alkanes. These media are of high fundamental importance as they help to fill the prominent gap that exists in our knowledge between the polar solvents and the gas phase. There are a number of difficulties when performing experimental studies of acid–base equilibria in such nonpolar media as alkanes, including extensive aggregation and often also precipitation of ionic species, and also scarcity of acids and bases that are sufficiently soluble in heptane, etc. [8]. We have succeeded in overcoming these difficulties by using the highly lipophilic phosphazene *t*-BuP<sub>4</sub>(dma) [16] (see Scheme 1) – a very strong sterically hindered base – as the deprotonating agent. The protonated form of this base – a large cation with very delocalized positive charge – is a good counterion because specific and electrostatic attraction effects between it and the anions are practically negligible.

Of the nonpolar media in which acidity scales have been created, heptane is to date the only one with dielectric constant less than 2 ( $D=1.92$ ). In such a nonpolar medium ions will not dissociate but form ion pairs or higher aggregates depending on the ions and medium properties. The acidities measured in such a medium are called ion-pair acidities and the equilibrium between two acids can be written:

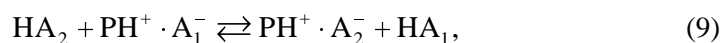

where  $PH^+$  denotes the protonated *t*-BuP<sub>4</sub>(dma) phosphazene. Thus the  $pK$  of the equilibrium 9 – obtained directly from the experiment – is the relative ion-pair acidity –  $\Delta pK_{ip}$  – of the acids  $HA_1$  and  $HA_2$ :

$$\Delta pK_{ip} = pK_{ip}(HA_2) - pK_{ip}(HA_1) = \log \frac{a(PH^+ \cdot A_1^-) \cdot a(HA_2)}{a(PH^+ \cdot A_2^-) \cdot a(HA_1)}. \quad (10)$$

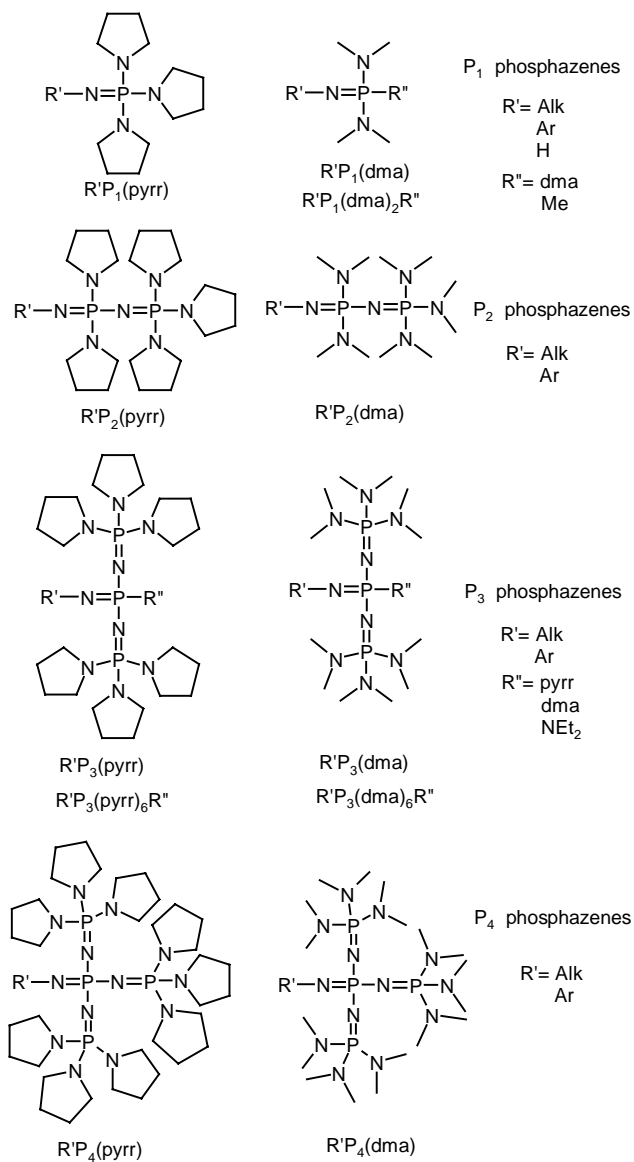

**Scheme 1.** Structures of the studied superbasic phosphazenes.

The scale [17, 18] that has been created by our group is presented in Table 1. It contains polyaromatic CH and NH acids, most of which are polyfluorinated. For the families of compounds studied it was found that the differentiating ability of acidities of heptane is only by a factor of 1.2–1.3 weaker than the gas phase [19–21] and that it has equal or better differentiating ability than DMSO or DME for CH acids or NH acids, respectively.

**Table 1.** Continuous self-consistent ion-pair acidity scale in heptane. The scale is anchored to arbitrarily chosen reference compound 3 [17, 18]

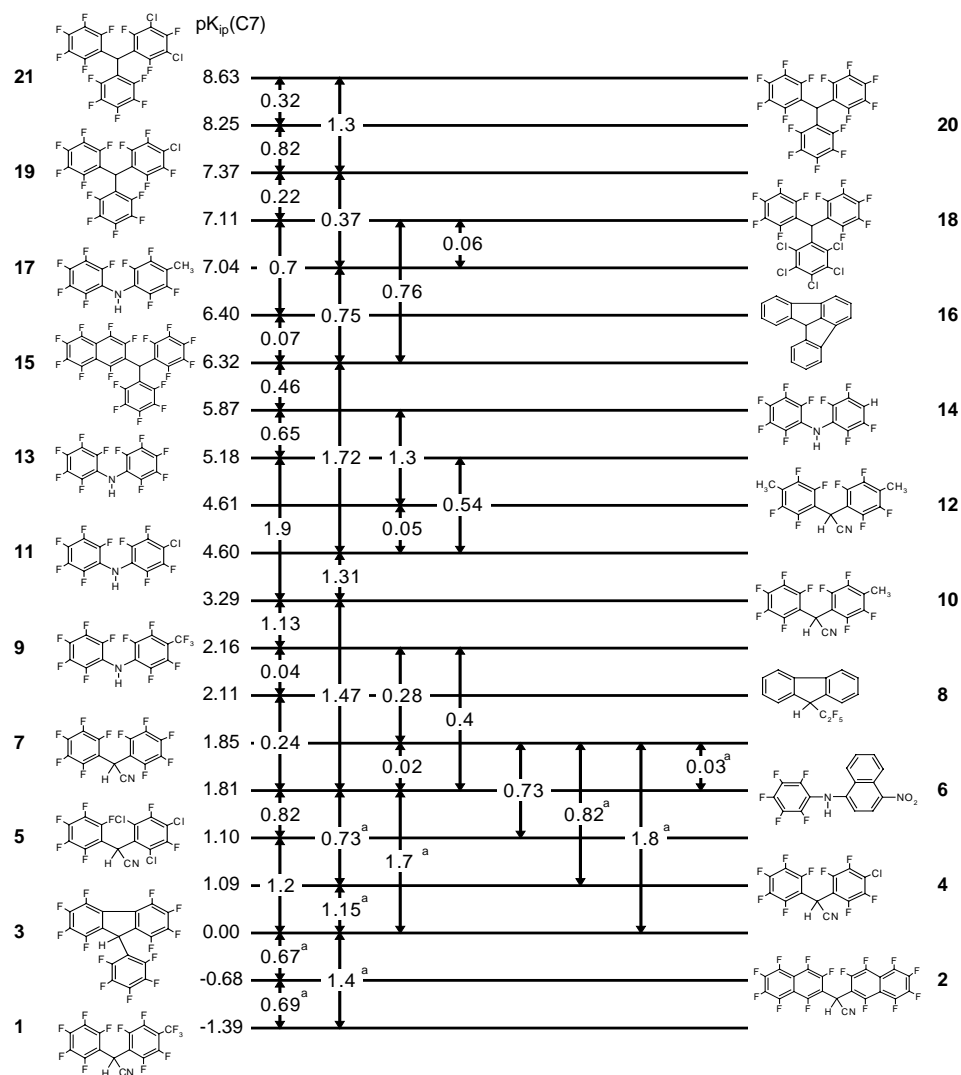

<sup>a</sup> Measurement results from [17]. Reproduced with permission from [18]. Copyright 2003 Am. Chem. Soc.

### ACIDITY SCALE IN ACETONITRILE

Acetonitrile (AN) has many properties that make it a suitable medium for acid–base studies. It has low basicity and very low ability to solvate anions [5]. The low basicity gives AN an advantage over the other very popular solvent for

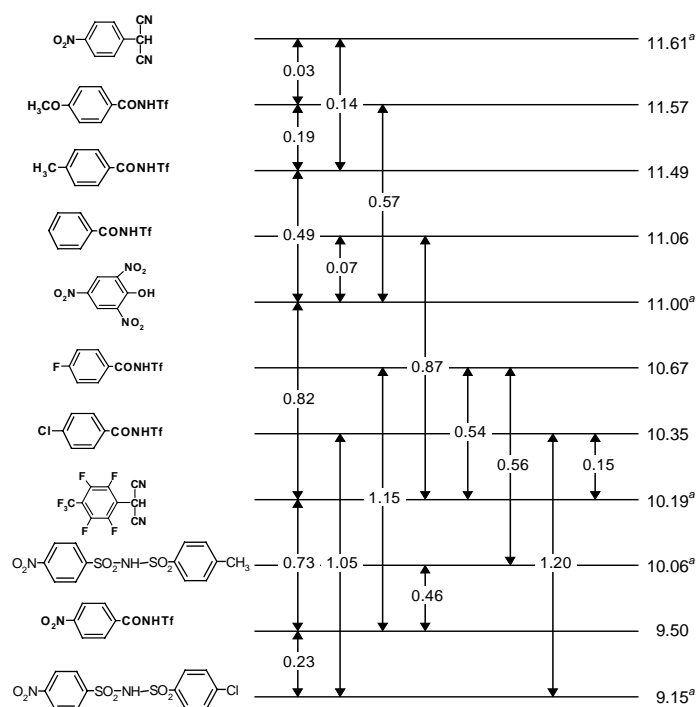

**Table 2.** Continuous self-consistent acidity scale of neutral and some cationic acids in acetonitrile

Compound	Measured $\Delta pK_a$	$pK_a$
2,4-dinitrophenol	0.54	16.66
(4-CF <sub>3</sub> C <sub>6</sub> F <sub>4</sub> ) <sub>2</sub> CHCN	*-1.92	16.14
3-CF <sub>3</sub> C <sub>6</sub> H <sub>4</sub> CH(CN) <sub>2</sub>	1.43	14.72
Saccharin	*-0.84	14.58
4-CH <sub>3</sub> C <sub>6</sub> F <sub>4</sub> CH(CN) <sub>2</sub>	0.15	14.58
4-CH <sub>3</sub> C <sub>6</sub> F <sub>4</sub> CH(CN) <sub>2</sub>	*-0.84	14.58
C <sub>6</sub> F <sub>5</sub> CH(CN) <sub>2</sub>	0.71	13.88
C <sub>6</sub> F <sub>5</sub> CH(CN) <sub>2</sub>	*-0.89	13.88
4-HC <sub>6</sub> F <sub>4</sub> CH(CN) <sub>2</sub>	0.03	13.01
4-HC <sub>6</sub> F <sub>4</sub> CH(CN) <sub>2</sub>	*-0.79	13.01
2-C <sub>10</sub> F <sub>7</sub> CH(CN) <sub>2</sub>	0.74	12.98
Tos <sub>2</sub> NH	1.38 0.26	12.23
Tos <sub>2</sub> NH	-0.62	11.97
4-NO <sub>2</sub> C <sub>6</sub> H <sub>4</sub> CH(CN) <sub>2</sub>	*-0.89	11.61
(C <sub>6</sub> H <sub>5</sub> SO <sub>2</sub> ) <sub>2</sub> NH	0.28	11.61
(C <sub>6</sub> H <sub>5</sub> SO <sub>2</sub> ) <sub>2</sub> NH	1.21	11.61
(C <sub>6</sub> H <sub>5</sub> SO <sub>2</sub> ) <sub>2</sub> NH	-0.98	11.61
4-ClC <sub>6</sub> H <sub>4</sub> SO <sub>2</sub> NHTos	0.60	11.34
4-ClC <sub>6</sub> H <sub>4</sub> SO <sub>2</sub> NHTos	0.60	11.34
4-ClC <sub>6</sub> H <sub>4</sub> SO <sub>2</sub> NHTos	-0.36	11.34
Picric acid	1.43	11.10
Picric acid	0.10	11.10
(4-ClC <sub>6</sub> H <sub>4</sub> SO <sub>2</sub> ) <sub>2</sub> NH	0.79	11.00
(4-ClC <sub>6</sub> H <sub>4</sub> SO <sub>2</sub> ) <sub>2</sub> NH	0.91	11.00
(4-ClC <sub>6</sub> H <sub>4</sub> SO <sub>2</sub> ) <sub>2</sub> NH	-0.82	11.00
4-CF <sub>3</sub> C <sub>6</sub> F <sub>4</sub> CH(CN) <sub>2</sub>	-0.01	10.20
4-CF <sub>3</sub> C <sub>6</sub> F <sub>4</sub> CH(CN) <sub>2</sub>	*-0.13	10.19
4-CF <sub>3</sub> C <sub>6</sub> F <sub>4</sub> CH(CN) <sub>2</sub>	0.14	10.19
4-NO <sub>2</sub> C <sub>6</sub> H <sub>4</sub> SO <sub>2</sub> NHTos	-0.52	10.06
4-NO <sub>2</sub> C <sub>6</sub> H <sub>4</sub> SO <sub>2</sub> NHTos	1.05	10.06
4-Cl-3-NO <sub>2</sub> C <sub>6</sub> H <sub>3</sub> SO <sub>2</sub> NHTos	*-0.82	10.06
4-Cl-3-NO <sub>2</sub> C <sub>6</sub> H <sub>3</sub> SO <sub>2</sub> NHTos	1.06	10.06
4-NO <sub>2</sub> C <sub>6</sub> H <sub>4</sub> SO <sub>2</sub> NHSO <sub>2</sub> C <sub>6</sub> H <sub>4</sub> -4-Cl	0.53	9.69
4-NO <sub>2</sub> C <sub>6</sub> H <sub>4</sub> SO <sub>2</sub> NHSO <sub>2</sub> C <sub>6</sub> H <sub>4</sub> -4-Cl	0.56	9.15
4-NO <sub>2</sub> C <sub>6</sub> H <sub>4</sub> SO <sub>2</sub> NHSO <sub>2</sub> C <sub>6</sub> H <sub>4</sub> -4-Cl	1.73	9.15
TosOH	2.3	8.6
(4-NO <sub>2</sub> C <sub>6</sub> H <sub>4</sub> SO <sub>2</sub> ) <sub>2</sub> NH	1.21 0.23	8.31
(4-NO <sub>2</sub> C <sub>6</sub> H <sub>4</sub> SO <sub>2</sub> ) <sub>2</sub> NH	1.3	8.31
1-C <sub>10</sub> H <sub>7</sub> SO <sub>3</sub> H	0.25	8.00
1-C <sub>10</sub> H <sub>7</sub> SO <sub>3</sub> H	*-0.50	8.00
C <sub>6</sub> H <sub>5</sub> CHTf <sub>2</sub>	0.19 1.04	7.83
C <sub>6</sub> H <sub>5</sub> CHTf <sub>2</sub>	0.54	7.83
4-ClC <sub>6</sub> H <sub>4</sub> SO <sub>3</sub> H	1.25	7.3
4-ClC <sub>6</sub> H <sub>4</sub> SO <sub>3</sub> H	0.53	7.3
3-NO <sub>2</sub> C <sub>6</sub> H <sub>4</sub> SO <sub>3</sub> H	*-0.51	6.76
3-NO <sub>2</sub> C <sub>6</sub> H <sub>4</sub> SO <sub>3</sub> H	0.51	6.76
4-NO <sub>2</sub> C <sub>6</sub> H <sub>4</sub> SO <sub>3</sub> H	0.44 0.75	6.71
4-NO <sub>2</sub> C <sub>6</sub> H <sub>4</sub> SO <sub>3</sub> H	1.28	6.71
TosNHTf	0.36	6.29
TosNHTf	0.62	6.29
C <sub>6</sub> H <sub>5</sub> SO <sub>2</sub> NHTf	*-0.83	6.01
C <sub>6</sub> H <sub>5</sub> SO <sub>2</sub> NHTf	0.98	6.01
4-ClC <sub>6</sub> H <sub>4</sub> SO <sub>2</sub> NHTf	*-0.70	5.46
4-ClC <sub>6</sub> H <sub>4</sub> SO <sub>2</sub> NHTf	0.77	5.46
2-NO <sub>2</sub> C <sub>6</sub> H <sub>4</sub> NH <sub>3</sub> <sup>+</sup>	*-0.70	5.30
2-NO <sub>2</sub> C <sub>6</sub> H <sub>4</sub> NH <sub>3</sub> <sup>+</sup>	0.53	5.30
4-ClC <sub>6</sub> H <sub>4</sub> SO(=NTf)NHTos	0.35	5.27
4-ClC <sub>6</sub> H <sub>4</sub> SO(=NTf)NHTos	0.38	5.27
2,4,6-Tf <sub>3</sub> C <sub>6</sub> H <sub>2</sub> OH	*-0.82	4.93
2,4,6-Tf <sub>3</sub> C <sub>6</sub> H <sub>2</sub> OH	0.75	4.93
4-NO <sub>2</sub> C <sub>6</sub> H <sub>4</sub> SO <sub>2</sub> NHTf	0.41	4.53
4-NO <sub>2</sub> C <sub>6</sub> H <sub>4</sub> SO <sub>2</sub> NHTf	0.94	4.53
4-NO <sub>2</sub> C <sub>6</sub> H <sub>4</sub> SO <sub>2</sub> NHTf	1.17	4.53
4-ClC <sub>6</sub> H <sub>4</sub> SO(=NTf)NHSO <sub>2</sub> C <sub>6</sub> H <sub>4</sub> -4-Cl	0.05	4.48
4-ClC <sub>6</sub> H <sub>4</sub> SO(=NTf)NHSO <sub>2</sub> C <sub>6</sub> H <sub>4</sub> -4-Cl	0.87	4.48
4-ClC <sub>6</sub> H <sub>4</sub> SO(=NTf)NHSO <sub>2</sub> C <sub>6</sub> H <sub>4</sub> -4-Cl	1.1	4.48
4-Cl-2-NO <sub>2</sub> C <sub>6</sub> H <sub>4</sub> NH <sub>3</sub> <sup>+</sup>	1.10	4.36
4-Cl-2-NO <sub>2</sub> C <sub>6</sub> H <sub>4</sub> NH <sub>3</sub> <sup>+</sup>	-0.31	4.36
2,3,5-tricyanocyclopentadiene	0.74	4.16
2,3,5-tricyanocyclopentadiene	0.20	4.16
4-ClC <sub>6</sub> H <sub>4</sub> SO(=NTf)NHSO <sub>2</sub> C <sub>6</sub> H <sub>4</sub> -4-NO <sub>2</sub>	0.50	3.75
4-ClC <sub>6</sub> H <sub>4</sub> SO(=NTf)NHSO <sub>2</sub> C <sub>6</sub> H <sub>4</sub> -4-NO <sub>2</sub>	*-0.31	3.75

Tos = H<sub>3</sub>CC<sub>6</sub>H<sub>4</sub>SO<sub>2</sub><sup>-</sup>, Tf = F<sub>3</sub>CSO<sub>2</sub><sup>-</sup>. Reproduced with permission from [9]. Copyright 1998 Am. Chem. Soc.

**Table 3.** Directly measured  $\Delta pK_a$  values of *N*-aroyltrifluoromethanesulfonamides relative to various reference acids with known  $pK_a$  values in AN



<sup>a</sup> Reference acids.  $pK_a$  values of the reference acids are from [9]. Table from [10]. Reproduced by permission of The Royal Society of Chemistry.

acid–base studies – DMSO, which is considerably more basic (stronger acceptor of hydrogen bonds). As AN has a high dielectric constant ( $D = 36.0$  [5]) it favours the dissociation of ion pairs into free ions. The autoprotolysis constant of AN is very low:  $pK_{\text{auto}} \geq 33$  [22] (even values of  $pK_{\text{auto}}$  as high as 44 have been suggested [16, 23]), which makes it a good differentiating solvent. Additionally, the advantages of AN are its transparency down to 190 nm and relative ease of purification. The acidity scale in AN is presented in Tables 2–4.

One can see that the replacement of only one oxygen atom in the benzoate anion ( $pK_a = 20.7$  [24]) by Yagupolskii's supersubstituent –  $(=NSO_2CF_3)$  increases the acidity of its conjugate NH acid by 9.6  $pK_a$  units whereas the replacement also of the second oxygen atom leads to a further significant increase (by 4.9  $pK_a$  units) of acidity: thus the total acidifying effect of transfer from benzoic acid to its benzamidine analogue, another NH acid, reaches 14.5 powers of ten. Similar enormous acidifying effect of this substituent was observed in DMSO and in the gas phase in the case of sequential substitution of two  $=O$  atoms by  $=NSO_2CF_3$  groups in toluene-*p*-sulfonamide [25] and in a somewhat lesser extent

**Table 4.** Directly measured  $\Delta pK_a$  values of compounds *N,N'*-bis(trifluoromethylsulfonyl)benzamidines relative to various reference acids with known  $pK_a$  values in AN

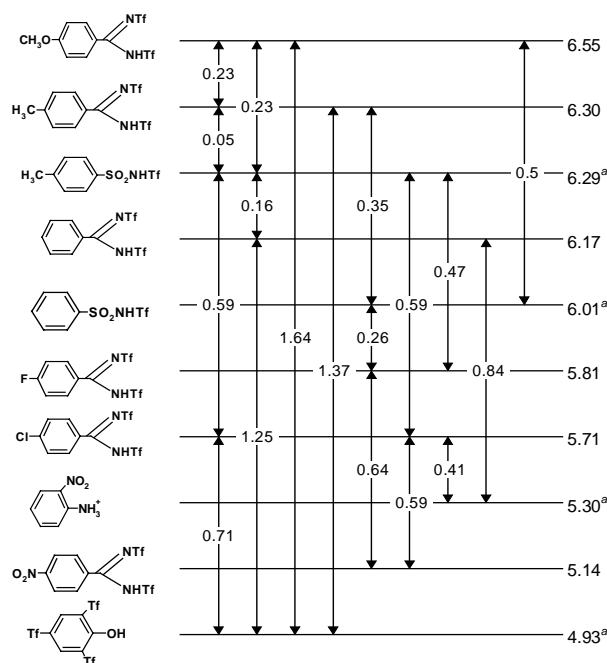

<sup>a</sup> Reference acids.  $pK_a$  values for the reference acids are from [9]. Table from [10]. Reproduced by permission of The Royal Society of Chemistry.

in the case of some sulfonamides (Table 2). These results confirm the earlier gas-phase data on the extraordinary acidifying effect of the  $=NSO_2CF_3$  substituent [19].

### BASICITY SCALE IN ACETONITRILE

Neutral organic bases have found a wide field of applications in the organic synthesis as reagents in base-mediated transformations and are often irreplaceable [26, 27]. They have many substantial advantages as compared to ionic bases, such as milder reaction conditions, enhanced reactivity of the more naked anions in the poorly associating ion pairs formed, and better solubility [28–30]. Several new and very promising families of strong neutral bases – “proton sponges” [31–33], guanidines [34], amidines, phosphazenes [28–30, 35, 36], phosphorus ylides [37, 38] – have emerged. Their quantitative basicity data must be known as these largely determine applicability of these bases in practice.

In spite of the contributions from several groups (especially the Schwesinger [28, 29], Sundermeyer [39], and Verkade [40] groups), the data on basicity in

AN in the region of DBU and above continue to be scarce in the literature. Our aim was to establish a self-consistent basicity scale of very wide range and to include various families of bases.

The reaction studied is given in Eq. 7 and the equilibrium constant formula for neutral bases  $B_1$  and  $B_2$  can be written as follows:

$$\Delta pK_a = pK_a(HB_2^+) - pK_a(HB_1^+) = \log \frac{[HB_2^+] \cdot [B_1]}{[HB_1^+] \cdot [B_2]} \quad (11)$$

In its current state, the scale [11] (Table 5) already contains 89 different bases and 180 independent  $\Delta pK_a$  measurements have been carried out so that the scale spans over 28  $pK_a$  units. The bases included are well-known anilines, pyridines, simple amines, phosphines, guanidines, amidines, and porphyrins. The most important family of bases included in this scale is phosphazenes, many of which were synthesized for the first time in our lab. These superbasic phosphazenes have proved to be very convenient and stable indicator bases in the high basicity range where there is a lack of good neutral indicator bases. They have the advantage that they possess an aromatic nucleus that is conjugated to the protonation centre of the molecule. This causes significant changes in UV-Vis spectra on protonation and therefore the protonation level of such compounds can be easily determined UV-Vis spectrophotometrically. The influence of substituents on the phenyl ring on the basicity of the phosphazene is easily predictable, providing the possibility of conveniently “tuning” the basicity of the compound. The possibility of synthesizing higher homologues of phosphazenes is well applicable for taking bigger leaps towards the more basic region.

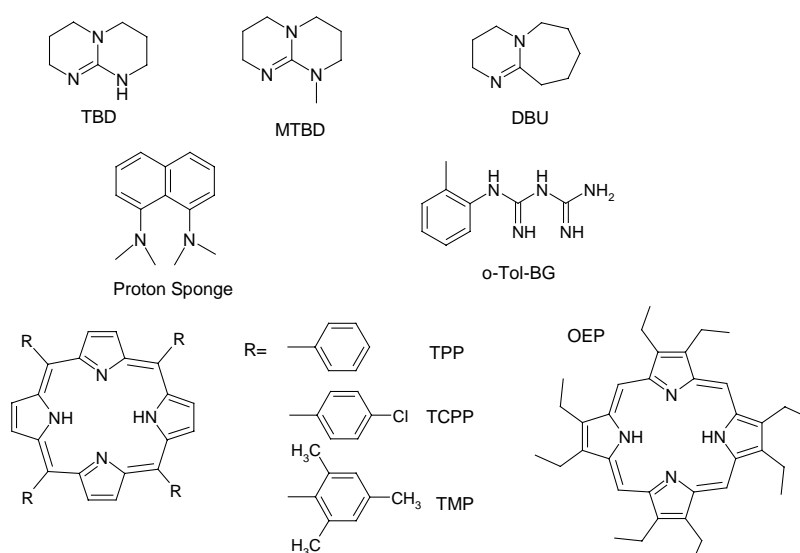

**Scheme 2.** Structures of some other studied bases.

Work is progressing to further supplement the scale by incorporating new types of bases and to study the effect of media on the basicity. Thorough analysis of the basicity data in AN available in the literature was carried out and it was shown that the basicity data from some authors are consistent with the present self-consistent basicity scale while the data from some others are not [11].

**Table 5.** Continuous self-consistent basicity scale of neutral bases in acetonitrile. See schemes 1 and 2 for designations of the compounds

Base	$pK_a(\text{AN})^b$	Directly measured $\Delta pK_a^a$
1 4-MeO-C <sub>6</sub> H <sub>4</sub> P <sub>3</sub> (dma)	31.99	
2 PhP <sub>3</sub> (dma)	31.48	0.80 (down), 0.51 (up)
3 2-Cl-C <sub>6</sub> H <sub>4</sub> P <sub>3</sub> (pyrr) <sub>6</sub> NEt <sub>2</sub>	31.19	0.70 (down), 0.98 (up)
4 4-CF <sub>3</sub> -C <sub>6</sub> H <sub>4</sub> P <sub>3</sub> (pyrr)	30.50	0.32 (down), 1.35 (up)
5 2-Cl-C <sub>6</sub> H <sub>4</sub> P <sub>3</sub> (dma) <sub>6</sub> NEt <sub>2</sub>	30.16	1.01 (down), 1.05 (up)
6 2,5-Cl <sub>2</sub> -C <sub>6</sub> H <sub>3</sub> P <sub>3</sub> (pyrr) <sub>6</sub> NEt <sub>2</sub>	29.16	0.08 (down), 1.05 (up)
7 4-CF <sub>3</sub> -C <sub>6</sub> H <sub>4</sub> P <sub>3</sub> (dma)	29.10	
8 EtP <sub>1</sub> (pyrr)	28.88	0.93 (down), 0.64 (up)
9 t-BuP <sub>1</sub> (pyrr)	28.42	0.86 (down), 0.17 (up), 0.61 (up), 1.36 (up), 1.6 (up)
10 4-MeO-C <sub>6</sub> H <sub>4</sub> P <sub>2</sub> (pyrr)	28.23	0.64 (down), 0.69 (down), 0.86 (up), 1.21 (up), 0.55 (up), 1.6 (up), 0.02 (up)
11 PhP <sub>2</sub> (pyrr)	27.55	0.69 (down), 1.21 (up), 0.55 (up), 1.6 (up), 0.02 (up)
12 MeP <sub>1</sub> (dma)	27.52	
13 HP <sub>1</sub> (pyrr)	27.01	0.60 (down), 1.59 (up), 0.55 (up), 1.70 (up)
14 t-BuP <sub>1</sub> (dma)	26.98	0.55 (down), 1.59 (up), 1.70 (up)
15 PhP <sub>2</sub> (dma)	26.46	0.55 (down), 0.46 (up), 0.61 (up)
16 TBD	26.03	
17 HP <sub>1</sub> (dma)	25.85	1.03 (down), 0.99 (up), 0.61 (up)
18 MTBD	25.49	
19 2-Cl-C <sub>6</sub> H <sub>4</sub> P <sub>2</sub> (pyrr)	25.42	0.08 (down), 1.57 (up)
20 DBU	24.34	1.05 (down), 1.57 (up), 1.20 (up)
21 4-NMe <sub>2</sub> -C <sub>6</sub> H <sub>4</sub> P <sub>1</sub> (pyrr)	23.88	0.45 (down), 1.55 (up), 1.20 (up)
22 4-MeO-C <sub>6</sub> H <sub>4</sub> P <sub>1</sub> (pyrr)	23.12	0.77 (down), 1.55 (up), 1.20 (up)
23 PhP <sub>1</sub> (pyrr)	22.34	0.74 (down), 1.55 (up), 1.20 (up)
24 PhP <sub>1</sub> (dma)	21.25	1.09 (down), 2.54 (up), 0.06 (up)
25 4-Br-C <sub>6</sub> H <sub>4</sub> P <sub>1</sub> (pyrr)	21.19	1.77 (down), 0.10 (down), 2.54 (up), 0.63 (up), 0.42 (up), 0.06 (up)
26 PhP <sub>1</sub> (dma) <sub>2</sub> Me	21.03	1.77 (down), 0.10 (down), 2.54 (up), 0.63 (up), 0.42 (up), 0.06 (up)
27 PhTMG	20.84	0.44 (down), 0.44 (down), 2.54 (up), 0.63 (up), 0.42 (up), 0.06 (up)
28 1-NaphtP <sub>1</sub> (pyrr)	20.61	0.44 (down), 0.44 (down), 2.54 (up), 0.63 (up), 0.42 (up), 0.06 (up), 0.80 (up), 0.62 (up)
29 2-Cl-C <sub>6</sub> H <sub>4</sub> P <sub>1</sub> (pyrr)	20.17	0.44 (down), 0.44 (down), 2.54 (up), 0.63 (up), 0.42 (up), 0.06 (up), 0.80 (up), 0.62 (up), 0.73 (up)

Table 5. Continued

30	4-CF <sub>3</sub> -C <sub>6</sub> H <sub>4</sub> P <sub>1</sub> (pyrr)	20.16	0.46							
31	2-Tol-1-BG	19.66			0.50		0.6			
32	pyrrolidine	19.56	0.59					2.10		
33	2-Cl-C <sub>6</sub> H <sub>4</sub> P <sub>1</sub> (dma)	19.07		1.59		1.69	0.48			
34	Et <sub>3</sub> N	18.82	1.07				0.46			
35	Proton Sponge	18.62	0.23						2.20	
36	2,6-Cl <sub>2</sub> -C <sub>6</sub> H <sub>3</sub> P <sub>1</sub> (pyrr)	18.56								
37	2,5-Cl <sub>2</sub> -C <sub>6</sub> H <sub>3</sub> P <sub>1</sub> (pyrr)	18.52	0.04				0.06		0.52	
38	4-NO <sub>2</sub> -C <sub>6</sub> H <sub>4</sub> P <sub>1</sub> (pyrr)	18.51	0.02	0.60				1.44	0.21	0.68
39	4-Pyrr-Pyridine	18.33	0.17				0.93		0.91	
40	4-NMe <sub>2</sub> -Pyridine	17.95	0.65		0.90		1.67			
41	2-NO <sub>2</sub> -4-Cl-C <sub>6</sub> H <sub>3</sub> P <sub>1</sub> (pyrr)	17.68		0.25						
42	4-NH <sub>2</sub> -Pyridine	17.62		0.08						1.04
43	2-NO <sub>2</sub> -5-Cl-C <sub>6</sub> H <sub>3</sub> P <sub>1</sub> (pyrr)	17.27	0.76	0.40						
44	PhCH <sub>2</sub> NH <sub>2</sub>	16.91								
45	2-NO <sub>2</sub> -4-CF <sub>3</sub> -C <sub>6</sub> H <sub>3</sub> P <sub>1</sub> (pyrr)	16.54		1.01	1.52		1.29			
46	2-NH <sub>2</sub> -Acridine	16.39	0.85			0.57				0.21
47	2-NH <sub>2</sub> -1-Me-Benzimidazole	16.31	0.09					1.31		
48	2-NH <sub>2</sub> -Benzimidazole	16.08		1.07					1.13	
49	2,3-(NH <sub>2</sub> ) <sub>2</sub> -Pyridine	15.24	0.84		1.10					
50	2,4,6-Me <sub>3</sub> -Pyridine	14.98	0.27		0.36				1.96	0.45
51	2,4-(NO <sub>2</sub> ) <sub>2</sub> -C <sub>6</sub> H <sub>3</sub> P <sub>1</sub> (pyrr)	14.88			0.10			0.22		
52	2,6-(NH <sub>2</sub> ) <sub>2</sub> -Pyridine	14.77				0.51			0.13	
53	2-NH <sub>2</sub> -Pyridine	14.47	0.75						0.35	
54	2,6-Cl <sub>2</sub> -4-NO <sub>2</sub> -C <sub>6</sub> H <sub>2</sub> P <sub>1</sub> (pyrr)	14.43		0.73			0.74		0.22	
55	4-MeO-Pyridine	14.23		1.55			0.34			0.22
56	3-NH <sub>2</sub> -Pyridine	14.17				0.34				0.05
57	2,6-Me <sub>2</sub> -Pyridine	14.13			0.06					
58	2,6-(NO <sub>2</sub> ) <sub>2</sub> -C <sub>6</sub> H <sub>3</sub> P <sub>1</sub> (pyrr)	14.12	1.72							
59	2-Me-Pyridine	13.32								
60	Pyridine	12.53			0.77					
61	OEP	12.37	0.66		0.15					
62	4-MeO-Aniline	11.86		0.83						1.01
63	2-methylquinolin-8-amine	11.54	0.31							
64	N,N-Me <sub>2</sub> -Aniline	11.43	0.07		0.95					
65	Aniline	10.62	0.77			1.15				
66	2-Me-Aniline	10.50								
67	TPP	10.41	0.22							
68	5-NO <sub>2</sub> -Benzimidazole	10.39				1.58				

Table 5. Continued

69	TMP	10.15	0.43	0.85																	
70	MePh <sub>2</sub> P	9.96			0.47			0.74	0.56												
71	T CPP	9.94	0.03				1.07		0.90			0.85									
72	2-MeO-Pyridine	9.93										0.60									
73	1-Napht-NH <sub>2</sub>	9.77	0.16		0.38																0.32
74	3-Cl-Pyridine	9.55	0.24				0.33														
75	4-Br-Aniline	9.43																			
76	2,4-F <sub>2</sub> -Aniline	8.39			1.06																
77	4-CF <sub>3</sub> -Aniline	8.03	1.57		0.35																
78	2-Cl-Aniline	7.86	0.20		0.71	0.35		1.77		0.17											
79	3-NO <sub>2</sub> -Aniline	7.68	0.01							0.17											
80	4-F-3-NO <sub>2</sub> -Aniline	7.67	0.05		0.04																
81	2,6-(MeO) <sub>2</sub> -Pyridine	7.64	0.04		0.88		1.51			0.07											0.07
82	Ph <sub>3</sub> P	7.61						0.85		1.40											
83	2-Cl-Pyridine	6.79	1.40																		
84	4-NO <sub>2</sub> -Aniline	6.22	0.01		0.57																
85	2,5-Cl <sub>2</sub> -Aniline	6.21	0.25		1.16		0.25														
86	Ph <sub>2</sub> NH	5.97	0.91				1.40														
87	2,6-Cl <sub>2</sub> -Aniline	5.06	0.25		1.18																
88	2-NO <sub>2</sub> -Aniline	4.80	1.30																		
89	4-Cl-2-NO <sub>2</sub> -Aniline	3.80			0.97																

<sup>a</sup> The numbers on the arrows are the experimental  $\Delta pK_a$  values from [11–15]. <sup>b</sup> Absolute  $pK_a$  values. Reproduced with permission from [11]. Copyright 2005 Am. Chem. Soc.

It was shown that the basicity of the PhP<sub>1</sub>(pyrr) family is less sensitive toward substitution on the aromatic ring than the basicity of analogously substituted anilines. Lower sensitivity can be due to the contribution of the ylenic (**a** in Eq. 12) structure in the substituted PhP<sub>1</sub>(pyrr) series and delocalization of the positive charge of the protonated form into the large phosphorane moiety.

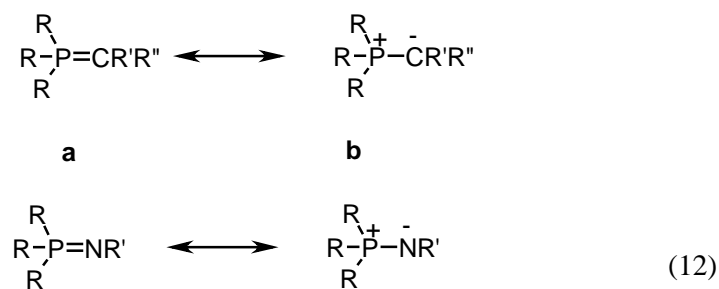

## BASICITY SCALE IN TETRAHYDROFURAN

Tetrahydrofuran (THF) is also a suitable solvent for studies of strong bases [28] as well as weak acids [41]. An additional advantage of THF is the direct relevance of the acidity and basicity data to organic synthesis, as deprotonation reactions of reactants, acting as weak acids, by strong bases in THF find very extensive application in organic synthesis [26–30]. The acidity and basicity data that exist in THF to date are scarce, however. THF has a similar differentiating ability (estimated  $pK_{\text{auto}} = 34.7$  [42]) to AN, is a better cation solvator ( $DN = 20.0$ ) than AN, but it solvates anions even more poorly than AN ( $AN = 8.0$ ). It also has a low dielectric constant ( $D = 7.58$  [6]) and, as a result, in THF the ion-pairing processes are much more favoured than in AN. Even at low concentrations the ion-pairing processes (first and last step in Eq. 13) must be considered when using THF. It is much more resistant to the superbases than AN. At least 5 orders of magnitude stronger bases can be studied in THF than in AN [16 and unpublished results from our lab].

In the UV–Vis spectrophotometric titration and  $^{13}\text{C}$  NMR methods used, the relative ion-pair basicities ( $\Delta pK_{\text{ip}}$  values, Eq. 14) of two bases present in the same THF solution were measured.

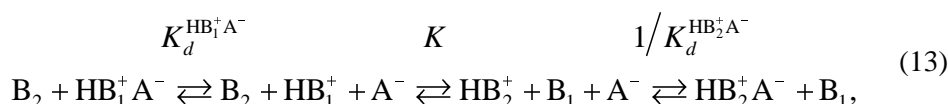

$$\Delta pK_{\text{ip}} = pK_{\text{ip}}(\text{HB}_2^+\text{A}^-) - pK_{\text{ip}}(\text{HB}_1^+\text{A}^-) = \log \frac{K \cdot K_d^{\text{HB}_1^+\text{A}^-}}{K_d^{\text{HB}_2^+\text{A}^-}} = \log \frac{a(\text{HB}_2^+\text{A}^-) \cdot a(\text{B}_1)}{a(\text{HB}_1^+\text{A}^-) \cdot a(\text{B}_2)}. \quad (14)$$

These  $\Delta pK_{\text{ip}}$  values were corrected for ion-pairing using the Fuoss equation as described in reference [43]. If the ion-pair's  $K_d$  values can be measured or estimated, the  $\Delta pK_{\alpha}$  (an estimate of the  $\Delta pK_{\text{a}}$ ) can be found as follows:

$$\Delta pK_{\alpha} = pK_{\alpha}(\text{HB}_2^+) - pK_{\alpha}(\text{HB}_1^+) = \Delta pK_{\text{ip}} - \log \frac{K_d^{\text{HB}_1^+\text{A}^-}}{K_d^{\text{HB}_2^+\text{A}^-}}. \quad (15)$$

Altogether 58 bases (pyridines, anilines, amines, guanidines, amidines, phosphazenes) are included and around 120 independent  $\Delta pK_{\text{ip}}$  measurements (see Tables 6 and 7) were carried out. These measurements give a continuous basicity scale [14, 15] in THF ranging from 2.6 (2-MeO-pyridine) to 26.6 (2-Cl-C<sub>6</sub>H<sub>4</sub>P<sub>4</sub>(pyrr) phosphazene) in the  $pK_{\alpha}$  units – that is for 24 orders of magnitude. The scale is anchored to the  $pK_{\alpha}$  value of triethylamine ( $pK_{\alpha} = 12.5$ ), which was proposed to be used as secondary standard by Morris's group [44]. The relatively good predictability of the basicity together with suitable spectral properties in the UV range make the arylphosphazenes (see Scheme 1) convenient neutral indicators in the medium of high basicity range where the choice of neutral basic indicators is currently very limited.



**Table 6.** Continuous self-consistent basicity scale of neutral bases in THF solution<sup>a</sup>

Compound	$pK_{ip}(\text{THF})$	$pK_a(\text{THF})$
EtP <sub>1</sub> (pyrr)	21.5	21.5
4-MeO-C <sub>6</sub> H <sub>4</sub> P <sub>2</sub> (pyrr)	20.9	21.3
H <sub>2</sub> NP <sub>1</sub> (pyrr)	20.7	20.8
PhP <sub>2</sub> (pyrr)	20.1	20.6
<i>t</i> -BuP <sub>1</sub> (pyrr)	20.1	20.2
TBD	19.7	19.4
PhP <sub>2</sub> (dma)	19.3	19.7
<i>t</i> -BuP <sub>1</sub> (dma)	18.8	18.8
DBU	17.9	16.6
4-Me <sub>2</sub> N-C <sub>6</sub> H <sub>4</sub> P <sub>1</sub> (pyrr)	17.1	17.1
TMG	16.9	15.3
2-Cl-PhP <sub>2</sub> (pyrr)	16.7	17.3
4-MeO-C <sub>6</sub> H <sub>4</sub> P <sub>1</sub> (pyrr)	16.6	16.6
PhP <sub>1</sub> (pyrr)	15.9	15.9
4-Br-C <sub>6</sub> H <sub>4</sub> P <sub>1</sub> (pyrr)	15.4	15.4
Pyrrolidine	15.3	13.5
PhP <sub>1</sub> (dma)	15.2	15.2
PhTMG	15.0	14.0
4-CF <sub>3</sub> -C <sub>6</sub> H <sub>4</sub> P <sub>1</sub> (pyrr)	14.6	14.6
1-NaphtP <sub>1</sub> (pyrr)	14.2	14.2
Et <sub>3</sub> N	14.1	12.5
2-Cl-C <sub>6</sub> H <sub>4</sub> P <sub>1</sub> (pyrr)	13.2	13.2
4-Me <sub>2</sub> N-Pyridine	13.0	11.2
2-Cl-C <sub>6</sub> H <sub>4</sub> P <sub>1</sub> (dma)	12.5	12.5
2,5-Cl <sub>2</sub> -C <sub>6</sub> H <sub>3</sub> P <sub>1</sub> (pyrr)	11.9	11.9
2,6-Cl <sub>2</sub> -C <sub>6</sub> H <sub>3</sub> P <sub>1</sub> (pyrr)	11.8	11.8
DMAN	11.7	11.1
2-NO <sub>2</sub> -4-Cl-C <sub>6</sub> H <sub>3</sub> P <sub>1</sub> (pyrr)	10.8	10.8
2-NO <sub>2</sub> -5-Cl-C <sub>6</sub> H <sub>3</sub> P <sub>1</sub> (pyrr)	10.1	10.1
2,4,6-Me <sub>3</sub> -Pyridine	9.6	8.1
2-NO <sub>2</sub> -4-CF <sub>3</sub> -C <sub>6</sub> H <sub>3</sub> P <sub>1</sub> (pyrr)	9.6	9.6
4-MeO-Pyridine	9.1	7.3
2,6-Me <sub>2</sub> -Pyridine	8.8	7.2
4-MeO-Aniline	8.3	6.5
2-Me-Pyridine	8.1	6.3
2,4-(NO <sub>2</sub> ) <sub>2</sub> -C <sub>6</sub> H <sub>3</sub> P <sub>1</sub> (pyrr)	8.0	8.0
2,6-Cl <sub>2</sub> -4-NO <sub>2</sub> -C <sub>6</sub> H <sub>2</sub> P <sub>1</sub> (pyrr)	7.8	7.8
2,6-(NO <sub>2</sub> ) <sub>2</sub> -C <sub>6</sub> H <sub>3</sub> P <sub>1</sub> (pyrr)	7.5	7.5
Pyridine	7.4	5.5
Aniline	7.0	5.2
2-Me-Aniline	6.9	5.1
N,N-Me <sub>2</sub> -Aniline	6.5	4.9
4-Br-Aniline	5.8	4.0
2-MeO-Pyridine	4.4	2.6

<sup>a</sup> The numbers on the arrows are the direct experimental  $\Delta pK_{ip}$  values (uncorrected for ion pairing) obtained from UV-Vis spectrophotometric measurements if not indicated otherwise.

<sup>b</sup> NMR measurements. Reproduced with permission from [14]. Copyright 2002 Am. Chem. Soc.

**Table 7.** Continuous self-consistent basicity scale of neutral bases in THF solution above DBU<sup>a</sup>

Compound	$pK_{ip}(\text{THF})^c$	$pK_a(\text{THF})^c$
2-Cl-C <sub>6</sub> H <sub>4</sub> P <sub>4</sub> (pyrr)	25.6	26.6
EtP <sub>2</sub> (dma)	24.9	25.3
4-MeO-C <sub>6</sub> H <sub>4</sub> P <sub>3</sub> (pyrr)	24.8	25.7
PhP <sub>3</sub> (pyrr)	24.1	25.0
4-MeO-C <sub>6</sub> H <sub>4</sub> P <sub>3</sub> (dma)	23.5	24.0
PhP <sub>3</sub> (dma)	23.0	23.5
4-CF <sub>3</sub> -C <sub>6</sub> H <sub>4</sub> P <sub>3</sub> (pyrr)	22.3	23.1
EtP <sub>1</sub> (pyrr)	21.7	21.7
TBD	21.7	21.0
4-CF <sub>3</sub> -C <sub>6</sub> H <sub>4</sub> P <sub>3</sub> (dma)	21.2	21.7
2-Cl-C <sub>6</sub> H <sub>4</sub> P <sub>3</sub> (pyrr) <sub>6</sub> NEt <sub>2</sub>	21.1	22.0
4-MeOC <sub>6</sub> H <sub>4</sub> P <sub>2</sub> (pyrr)	20.8	21.5
HP <sub>1</sub> (pyrr)	20.8	20.8
MeP <sub>1</sub> (dma)	20.7	20.7
2-Cl-C <sub>6</sub> H <sub>4</sub> P <sub>3</sub> (dma) <sub>6</sub> NEt <sub>2</sub>	20.3	20.8
PhP <sub>2</sub> (pyrr)	20.2	20.9
t-ButP <sub>1</sub> (pyrr)	20.2	20.2
HP <sub>1</sub> (dma)	19.7	19.7
PhP <sub>2</sub> (dma)	19.4	19.8
2,5-Cl <sub>2</sub> -C <sub>6</sub> H <sub>3</sub> P <sub>3</sub> (pyrr) <sub>6</sub> NEt <sub>2</sub>	19.3	20.2
t-ButP <sub>1</sub> (dma)	18.9	18.9
MTBD	18.6	17.9
DBU	18.0	16.8
4-Me <sub>2</sub> N-C <sub>6</sub> H <sub>4</sub> P <sub>1</sub> (pyrr)	17.3	17.3
TMG	17.0	15.5
2-Cl-C <sub>6</sub> H <sub>4</sub> P <sub>2</sub> (pyrr)	16.8	17.5
4-MeO-C <sub>6</sub> H <sub>4</sub> P <sub>1</sub> (pyrr)	16.8	16.8
PhP <sub>1</sub> (pyrr)	16.0	16.0
PhP <sub>1</sub> (dma) <sub>2</sub> Me	15.4	15.5
PhTMG	15.0 <sup>b</sup>	14.0 <sup>b</sup>
4-CF <sub>3</sub> -C <sub>6</sub> H <sub>4</sub> P <sub>1</sub> (pyrr)	14.6 <sup>b</sup>	14.6 <sup>b</sup>

<sup>a</sup> The numbers on the arrows are the direct experimental  $\Delta pK_{ip}$  values (uncorrected for ion pairing) obtained from UV-Vis spectrophotometric measurements. <sup>b</sup> Value from [14]. <sup>c</sup> Absolute  $pK_{ip}(\text{THF})$  and  $pK_a(\text{THF})$  estimated values for conjugate acids of the respective bases. Reproduced with permission from [15]. Copyright 2003 Am. Chem. Soc.

In general, anilines, pyridines, and phosphazenes are slightly better differentiated in THF than in AN and in both aforementioned solvents better than in water [14, 15]. For only *para*-substituted arylphosphazenes AN appears to be 1.3 times better differentiating medium than THF [11]. It is interesting to

compare the basicity data in solvents and gas phase. The general correlation of free-ion basicities ( $pK_a$ ) in THF with gas-phase basicities is rather poor [15]. Also, no well-defined basicity relationship in these two media was obtained for the separate families of anilines or pyridines. A visible trend is that smaller molecules with unhindered basicity centres (pyrrolidine, anilines) are relatively more basic in THF than they would be expected from the correlations with the gas-phase data. This can be explained by the ability of THF to solvate smaller and more naked ions better than larger and sterically crowded ones.

### FUTURE PLANS

Work is in progress at our laboratory and new results are obtained and published on a regular basis. The main directions are currently the following:

- Further extension of the scales that have been established in different media by incorporating new compounds and new compound families. Studies (both experimental and theoretical) of the influence of structure variation and homologization on the acid–base properties of compounds. Interconnection of our scales with scales from other presently active authors by incorporating their compounds to our scales and our compounds to theirs. Critical analysis of available literature data and interconnection of these to our data.
- Creating self-consistent acidity and basicity scales in solvents where they do not yet exist. In particular our attention is focused on very nonpolar solvents and solvents where extreme acidities and basicities can be realized. For the latter goal the “very nonpolar” ones are in principle well suited but have the disadvantage that a large part of the potentially interesting compounds (and/or their salts) are insoluble. It is important to have the same compound families on the scales in different media. This allows for a firm relationship between the different scales and working towards the so-called *universal scale* – a scale that allows one to make reliable predictions across different solvents and different compound families.
- Rigorous anchoring of the scales in nonpolar media. In both heptane and THF the anchor points are currently arbitrary. Work is in progress to measure/estimate absolute acidity or basicity values for at least some few compounds in these solvents. Thereafter these compounds can be used as anchor points.
- Experimentally establishing the aggregation state of the species in the low polarity solvents. Thus far we have mostly relied on the results from other authors and on the experimental conditions that permit the minimization of the aggregation effects. This is not an entirely satisfactory approach because substantial uncertainty remains about the state of the species.

### ACKNOWLEDGEMENTS

This work was supported by grants 5800, 5226, 5508, and 5254 from the Estonian Science Foundation.

## REFERENCES

1. Bell, R. P. *The Proton in Chemistry*, 2nd ed. Chapman and Hall, London, 1973 and references therein.
2. Palm, V. (ed.). *Tables of Rate and Equilibrium Constants of Heterolytic Organic Reactions*. VINITI, Moscow–Tartu, 1975–1985.
3. Izutsu, K. *Acid–Base Dissociation Constants in Dipolar Aprotic Solvents*. IUPAC Chemical Data Series No. 35, Blackwell Scientific, Oxford, 1990.
4. Bartmess, J. E. *Negative Ion Energetics Data* (Mallard, W. G. & Linstrom, P. J., eds.). NIST Standard Reference Database No. 69, National Institute of Standards and Technology, Gaithersburg MD 20899, 1997 (<http://webbook.nist.gov>).
5. Coetsee, J. F. Ionic reactions in acetonitrile. *Prog. Phys. Org. Chem.*, 1967, **4**, 45–92 and references therein.
6. Reichardt, C. *Solvents and Solvent Effects in Organic Chemistry*, 2nd ed. VCH, Weinheim, 1988.
7. Bordwell Tables on the Web: <http://www.chem.wisc.edu/areas/reich/pkatable/>
8. Streitwieser, A. Jr., Juaristi, E. & Nebenzahl, L. L. Equilibrium carbon acidities in solution. In *Comprehensive Carbanion Chemistry. Part A. Structure and Reactivity* (Buncel, E. & Durst, T., eds.) Elsevier, Amsterdam, 1980, 323–381.
9. Leito, I., Kaljurand, I., Koppel, I. A., Yagupolskii, L. M. & Vlasov, V. M. Spectrophotometric acidity scale of strong neutral Brønsted acids in acetonitrile. *J. Org. Chem.*, 1998, **63**, 7868–7874.
10. Yagupolskii, L. M., Petrik, V. N., Kondratenko, N. V., Sooväli, L., Kaljurand, I., Leito, I. & Koppel, I. A. The immense acidifying effect of the supersubstituent =NSO<sub>2</sub>CF<sub>3</sub> on the acidity of amides and amidines of benzoic acids in acetonitrile. *J. Chem. Soc., Perkin Trans.*, **2**(11), 2002, 1950–1955.
11. Kaljurand, I., Kütt, A., Sooväli, L., Rodima, T., Mäemets, V., Leito, I. & Koppel, I. A. Extension of the self-consistent spectrophotometric basicity scale in acetonitrile to full span of 28 pK<sub>a</sub> units: unification of different basicity scales. *J. Org. Chem.*, 2005, **70**, 1019–1028 and references therein.
12. Kaljurand, I., Rodima, T., Leito, I., Koppel, I. & Schwesinger, R. Self-consistent spectrophotometric basicity scale in acetonitrile covering the range between pyridine and DBU. *J. Org. Chem.*, 2000, **65**, 6202–6208.
13. Inamo, M., Kohagura, T., Kaljurand, I. & Leito, I. Sitting-atop complex formation of 2,3,7,8,12,13,17,18-octaethylporphyrin with copper(II) ion in acetonitrile. *Inorg. Chim. Acta*, 2002, **340**, 87–96.
14. Rodima, T., Kaljurand, I., Pihl, A., Mäemets, V., Leito, I. & Koppel, I. A. Acid–base equilibria in nonpolar media. 2. Self-consistent basicity scale in THF solution ranging from 2-methoxy-pyridine to EtP<sub>1</sub>(pyrr) phosphazene. *J. Org. Chem.*, 2002, **67**, 1873–1881.
15. Kaljurand, I., Rodima, T., Pihl, A., Mäemets, V., Leito, I., Koppel, I. A. & Mishima, M. Acid–base equilibria in nonpolar media. 4. Extension of the self-consistent basicity scale in THF medium. Gas-phase basicities of phosphazenes. *J. Org. Chem.*, 2003, **68**, 9988–9993.
16. Schwesinger, R. & Schlemper, H. Peralkylated polyaminophosphazenes – extremely strong, neutral nitrogen bases. *Angew. Chem. Int. Ed. Engl.*, 1987, **26**, 1167–1169.
17. Leito, I., Rodima, T., Koppel, I. A., Schwesinger, R. & Vlasov, V. M. Acid–base equilibria in nonpolar media. 1. A spectrophotometric method for acidity measurements in heptane. *J. Org. Chem.*, 1997, **62**, 8479–8483.
18. Rõõm, E.-I., Kaljurand, I., Leito, I., Rodima, T., Koppel, I. A. & Vlasov, V. M. Acid–base equilibria in nonpolar media. 3. Expanding the spectrophotometric acidity scale in heptane. *J. Org. Chem.*, 2003, **68**, 7795–7799.
19. Koppel, I. A., Taft, R. W., Anvia, F., Zhu, S.-Z., Hu, L.-Q., Sung, K.-S., DesMarteau, D. D., Yagupolskii, L. M., Yagupolskii, Y. L., Ignat'ev, N. V., Kondratenko, N. V., Volkonskii, A. Y., Vlasov, V. M., Notario, R. & Maria, P.-C. The gas-phase acidities of very strong neutral Brønsted acids. *J. Am. Chem. Soc.*, 1994, **116**, 3047–3057 and references therein.

20. Koppel, I. A., Koppel, J., Pihl, V., Leito, I., Mishima, M., Vlasov, V. M., Yagupolskii, L. M. & Taft, R. W. Comparison of Brønsted acidities of neutral CH acids in gas phase and dimethyl sulfoxide. *J. Chem. Soc., Perkin Trans.*, **2**(6), 2000, 1125–1133.
21. Koppel, I., Koppel, J., Maria, P.-C., Gal, J.-F., Notario, R., Vlasov, V. M. & Taft, R. W. Comparison of Brønsted acidities of neutral NH-acids in gas phase, dimethyl sulfoxide, and water. *Int. J. Mass Spectrom. Ion Processes*, 1998, **175**, 61–69.
22. Kolthoff, I. M. & Chantooni, M. K. Jr. Autoprotolysis constant of acetonitrile. *J. Phys. Chem.*, 1968, **72**, 2270–2272.
23. Bernasconi, C. M., Leyes, A. E., Ragains, M. L., Shi, Y., Wang, H. & Wulff, W. D. Physical organic chemistry of transition metal carbene complexes. 14. Thermodynamic acidity measurements of Fischer carbene complexes in acetonitrile. *J. Am. Chem. Soc.*, 1998, **120**, 8632–8639.
24. Kolthoff, I. M. & Chantooni, M. K. Jr. Conductometric, potentiometric, and spectrophotometric determination of dissociation constants of substituted benzoic acids in acetonitrile. *J. Phys. Chem.*, 1966, **70**, 856–866.
25. Koppel, I. A., Koppel, J., Leito, I., Koppel, I., Mishima, M. & Yagupolskii, L. M. The enormous acidifying effect of the supersubstituent =NSO<sub>2</sub>CF<sub>3</sub> on the acidity of derivatives of benzenesulfonamide and toluene-*p*-sulfonamide in the gas phase and in dimethyl sulfoxide. *J. Chem. Soc., Perkin Trans.*, **2**(2), 2001, 229–232.
26. *Encyclopedia of Reagents for Organic Synthesis* (Paquette, L. A., ed.). Wiley, 1995.
27. Oediger, H., Möller, F. & Eiter, K. Bicyclic amidines as reagents in organic syntheses. *Synthesis*, 1972, 591–598.
28. Schwesinger, R., Schlemper, H., Hasenfratz, C., Willaredt, J., Dambacher, T., Breuer, T., Ottaway, C., Fletschinger, M., Boele, J., Fritz, H., Putzas, D., Rotter, H. W., Bordwell, F. G., Satish, A. V., Ji, G.-Z., Peters, E.-M., Peters, K., von Schnering, H. G. & Walz, L. Extremely strong, uncharged auxiliary bases; monomeric and polymer-supported polyaminophosphazenes (P-2-P-5). *Liebigs Ann.*, 1996, 1055–1081 and references therein.
29. Schwesinger, R., Willaredt, J., Schlemper, H., Keller, M., Schmitt, D. & Fritz, H. Novel, very strong, uncharged auxiliary bases – design and synthesis of monomeric and polymer-bound triaminoiminophosphorane bases of broadly varied steric demand. *Chem. Ber.*, 1994, **127**, 2435–2454 and references therein.
30. Tang, J., Dopke, J. & Verkade, J. G. Synthesis of new exceedingly strong non-ionic bases: RN : P(MeNCH<sub>2</sub>CH<sub>2</sub>)<sub>3</sub>N. *J. Am. Chem. Soc.*, 1993, **115**, 5015–5020 and references therein.
31. Llamas-Saiz, A. L., Foces-Foces, C. & Elguero, J. Proton sponges. *J. Mol. Struct.*, 1994, **328**, 297–323 and references therein.
32. Brzezinski, B., Schroeder, G., Grech, E., Malarski, Z. & Sobczyk, L. Basicity, IR-spectra and protonation of some proton sponges in acetonitrile. *J. Mol. Struct.*, 1992, **274**, 75–82.
33. Koppel, I. A., Koppel, J. B. & Pihl, V. O. Basicity of 1,8-bis(dimethylamino)naphthalene, cryptofix[2.2.2] and trimethylamine oxide in acetonitrile. *Org. React.*, 1987, **24**, 387–398.
34. Leffek, K. T., Pruszynski, P. & Thanapaalasingham, K. Basicity of substituted 2-phenyl-1,1,3,3-tetramethylguanidines and other bases in acetonitrile solvent. *Can. J. Chem.*, 1989, **67**, 590–595.
35. Raczyńska, E. D., Decouzon, M., Gal, J.-F., Maria, P.-C., Wozniak, K., Kurg, R. & Carins, S. N. Superbases and superacids in the gas phase. *Trends Org. Chem.*, 1998, **7**, 95–103 and references therein.
36. Koppel, I. A., Schwesinger, R., Breuer, T., Burk, P., Herodes, K., Koppel, I., Leito, I. & Mishima, M. Intrinsic basicities of phosphorus imines and ylides: a theoretical study. *J. Phys. Chem. A*, 2001, **105**, 9575–9586.
37. Johnson, A. W. (with special contributions by Kaska, W. C., Starzewski, K. A. O. & Dixon, D. A.) *Ylides and Imines of Phosphorus*. Wiley, New York, 1993.
38. Goumri-Magnet, S., Guerret, O., Gornitzka, H., Cazaux, J. B., Bigg, D., Palacios, F. & Bertrand, G. Free and supported phosphorus ylides as strong neutral Brønsted bases. *J. Org. Chem.*, 1999, **64**, 3741–3744 and references therein.

39. Raab, V., Kipke, J., Gschwind, R. M. & Sundermeyer, J. 1,8-bis(tetramethylguanidino)naphthalene (TMGN): a new, superbasic and kinetically active "proton sponge". *Chem. Eur. J.*, 2002, **8**, 1682–1693 and references therein.
40. Verkade, J. G. P(RNCH<sub>2</sub>CH<sub>2</sub>)<sub>3</sub>N: very strong non-ionic bases useful in organic synthesis. *Top. Curr. Chem.*, 2003, **223**, 1–44 and references therein.
41. Bors, D. A., Kaufman, M. J. & Streitwieser, A. Jr. Carbon acidity. 67. The indicator scale of cesium ion pairs in tetrahydrofuran. *J. Am. Chem. Soc.*, 1985, **107**, 6975–6982.
42. Barbosa, J., Barrón, D. & Buti, S. Chromatographic behaviour of ionizable compounds in liquid chromatography. Part I. pH scale, p*K*(a) and pH(s) values for standard buffers in tetrahydrofuran-water. *Anal. Chim. Acta*, 1999, **389**, 31–42.
43. Fuoss, R. M. Ionic association. III. The equilibrium between ion pairs and free ions. *J. Am. Chem. Soc.*, 1958, **80**, 5059–5061.
44. Abdur-Rashid, K., Fong, T. P., Greaves, B., Gusev, D. G., Hinman, J. G., Landau, S. E., Lough, A. J. & Morris, R. H. An acidity scale for phosphorus-containing compounds including metal hydrides and dihydrogen complexes in THF: toward the unification of acidity scales. *J. Am. Chem. Soc.*, 2000, **122**, 9155–9171.

## **Kooskõlalised happelisuse ja aluselisuse skaalad mittevesikeskkondades**

Ivo Leito, Ivari Kaljurand, Toomas Rodima, Agnes Kütt, Aino Pihl,  
Eva-Ingrid Rõõm, Lilli Sooväli, Vahur Mäemets, Viljar Pihl  
ja Ilmar A. Koppel

On antud ülevaade mittevesikeskkondades kooskõlaliste happelisuse ja aluselisuse skaalade koostamise meetodist ning hetkeseisust selle meetodi rakendamisel erinevates keskkondades. Kõnealune meetod kujutab endast kahe happe (kahe aluse) segu UV–Vis-spektrofotomeetrilist tiitrimist mitteneelava aluse (happe) lahusega. Tiitrimise andmetest on võimalik leida nende kahe happe (aluse) suhteline happelisus (suhteline aluselisus) – nende ainete p*K*<sub>a</sub>-väärtuste erinevus ( $\Delta pK_a$ ). Kui kasutada suurt erinevate p*K*<sub>a</sub>-väärtustega hapete (aluste) valimit ja mõõta iga happe (aluse) suhtelist happelisust mitme teise suhtes, siis on võimalik koostada kooskõlaline happelisuse (aluselisuse) skaala.  $\Delta pK_a$ -väärtusi on võimalik määrata väga kõrge täpsusega, sest paljud olulised veallikad (esmajärgjekorras lisandid lahustis ja ainetes endis) mõjutavad kummagi aine p*K*<sub>a</sub>-väärtust sarnaselt ning taanduvad (vähemalt osaliselt) välja. Kirjeldatud meetodi abil on loodud kooskõlalised happelisuse skaalad heptaanis ning atsetonitriilis ja kooskõlalised aluselisuse skaalad atsetonitriilis ja tetraahüdofuraanis. Artiklis on käsitletud senikoostatud skaalaid ja kirjeldatud lühidalt tulevikuplaane.