

Determination of the time behaviour of thermocouples for sensor speedup and medium supervision

Bernhard Sarnes^a and Elmar Schrüfer^b

^a DB Systemtechnik, Deutsche Bahn, D 80939 München, Germany; bernhard.sarnes@bahn.de

^b Messsystem- und Sensortechnik, Technische Universität München, Theresienstr. 90, D 80290 München, Germany; e.schruefer@tum.de

Received 17 July 2007

Abstract. Thermocouples can not only be used for temperature measurement, but also for supervising the surrounding medium. For both applications the knowledge of the thermocouple time constant is necessary. As the time constant changes with operational conditions, online calibration is needed. This aim has been achieved for metallic sheathed thermocouples by modelling and test measurements.

Key words: sheathed thermocouples, response time, dynamic sensor correction, state of the medium, process supervision.

1. THERMOCOUPLE

For temperature measurement with sheathed thermocouples the Seebeck effect is used. It describes the conversion of the temperature difference into electrical voltage. The used sheathed thermocouples consist of the following components (Fig. 1.1): a) thermal shanks of the materials A and B, the junction AB is the measuring point; b) balance conductors of the materials, A' and B'; c) connection lines to the voltage measuring instrument from the material C.

The measured thermovoltage U is approximately proportional to the temperature difference $\vartheta_2 - \vartheta_1$:

$$U = \int_{\vartheta_1}^{\vartheta_2} \varepsilon_{AB}(\vartheta) d\vartheta, \quad (1.1)$$

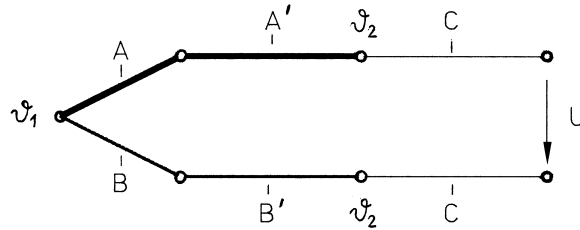

Fig. 1.1. The thermocouple.

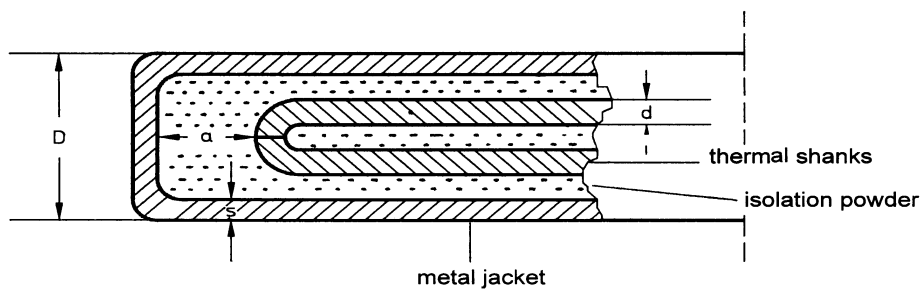

Fig. 1.2. Cross-section of an isolated sheathed thermocouple.

where ϑ_1 and ϑ_2 are temperatures ($^{\circ}\text{C}$) and $\varepsilon_{AB}(\vartheta)$ is the Seebeck coefficient ($\text{V}/^{\circ}\text{C}$).

The thermowires are embedded in a ceramic insulating compound (magnesium oxide or aluminium oxide). A metal jacket surrounds the insulating compound and thermowires (Fig. 1.2). The following realization forms are possible:

- a) the measuring point is welded and isolated from the sheath,
- b) the measuring point is welded together with the sheath and is grounded,
- c) the measuring point is open.

2. MODELLING AND CALCULATION OF THE TIME BEHAVIOUR

If the dimensions and material constants of sheathed thermocouples are known, it is possible to calculate the time behaviour of the sheathed thermocouples. Basis for these calculations is the solution of the Fourier heat conduction equation and the calculation of the surface heat transfer coefficient between the medium to be measured and the sheathed thermocouple [1]. For the solution of the Fourier heat conduction equation, thermal conductivity, specific heat capacity and density of the used materials are required (Table 2.1).

For the time behaviour, heat transfer coefficient of the thermocouple surface is much more important than the material data in Table 2.1. It can be calculated from flow-mechanical data. For its determination one has to determine the

Table 2.1. Characteristics of the thermocouple materials at 20°C [2–5]

Material	Composition	Density, kg/m ³	Specific heat capacity, J/kgK	Heat conductivity, W/mK	Specific resistance, Ωmm ² /m
Copper	99% Cu	8954	383	386	0.017
Konstantan	60% Cu	8922	410	22.7	0.488
	40% Ni				
Iron	99% Fe	7897	452	73	0.119
Nickel chrome	90% Ni	8666	444	17.5	0.716
	10% Cr				
Nickel (L-nickel)	99% Ni	8906	446	46	0.268
Inconel	76% Ni	8510	461	17.5	
	15% Cr				
	8% Fe				
Chrom-nickel steel	71% Fe	7817	460	16.3	
	18% Cr				
	8% Ni				
Magnesium oxide 80% condensed	97% MgO	2848	940	1.44	
Magnesium oxide 60% condensed	97% MgO	2385	940	0.85	

kinematic viscosity, the Reynolds number, the Nusselt number and the surface heat transfer coefficient. The results of the calculations are presented in Table 2.2. The heat transfer coefficient depends strongly on the medium and on the diameter of the thermocouple.

As the sheathed thermocouple can be considered as a rotation-symmetrical body, the temperature is independent of the angular coordinate. The Fourier differential equation for constant, invariable material values (thermal conductivity, specific heat capacity and density) becomes

$$\frac{\delta^2 \vartheta}{\delta r^2} + \frac{1}{r} \frac{\delta \vartheta}{\delta r} + \frac{\delta^2 \vartheta}{\delta z^2} + \frac{\bar{q}}{\lambda} = \frac{c \rho}{\lambda} \frac{\delta \vartheta}{\delta t}, \quad (2.1)$$

where r is the radial and z the axial coordinate (m), \bar{q} is the heat flow per volume unit (W/m³), c is the specific heat capacity (J/kgK), ρ is the density, λ is the heat conductivity (W/mK) and t is time (s).

Table 2.2. Surface heat transfer coefficients in W/m²K 20°C

Medium	Speed, m/s	Diameter, mm							
		0.25	0.5	1.0	1.5	2.0	3.0	4.5	6.0
Water	0.4	29 500	20 700	14 600	11 900	10 300	8 400	6 860	5 940
	0.2	21 100	14 700	10 300	8 430	7 290	5 940	4 850	4 200
Air	2	327	224	155	125	108	87	71	61
	1	242	163	112	90	77	63	51	44

A boundary condition must be introduced for the body surface. The standard solution of the Fourier differential equation for this case contains Bessel functions of the 1st and 2nd order. But for inhomogeneous, multilayer bodies as sheathed thermocouples the Fourier differential equation cannot be solved analytically. A discretization is necessary in the form of finite elements. The thermocouple is divided into a limited number of volume elements. The material values must be known for every element. For each of these elements a translation is made from the continuous system to the discrete one. The mass of the volume element is concentrated into one single point. Then for every element a simple differential equation with the time as a variable has to be solved instead of a partial differential equation. With smaller volume elements the error by the discretization decreases, but on the other hand the numerical effort will increase.

For electrical engineers it is helpful to display the physical system as an equivalent electrical network. Then the finite elements of the thermocouple can be treated analogically to electrical components. The heat conduction resistance and heat transfer resistance are associated to electrical resistors. The heat capacity corresponds to the electrical capacity. The temperature corresponds to the voltage and the heat flow to the electrical current. An electrical capacity is associated with each volume element. In addition, two resistors (heat conduction resistors) lead from every volume element to neighbouring volume elements (capacities) in axial direction and two resistors to neighbouring volume elements in radial direction. The volume elements at the sheathed thermocouple surface have the medium to be measured as the neighbouring volume elements. The resistor in the direction to the medium corresponds to the heat transfer resistor (Fig. 2.1).

At the beginning of the modelling, the thermocouple was simulated by 567 volume elements. But this discretization is unnecessary high. The uncertainties in modelling are caused less by the number of the cells, but more by the uncertainties of the material data, especially by the uncertainty of the heat transfer coefficient. Therefore in many applications a model of 2nd order is sufficient in order to describe the time behaviour of the thermocouple (Fig. 2.2). For this model of 2nd order only two volume elements are considered. Therefore two heat capacities and two thermal resistances are used. Altogether the knowledge of the following quantities is necessary: heat capacity of the sheath C_M , heat capacity of the insulating material and the thermo shanks C_I . The heat current flows through the heat transfer resistor R_U to the sheath and through the heat conduction resistor R_L to the measuring point.

With the model of 567th order, 50 and 90% final value times (the times when 50 or 90% of the final steady state temperatures are achieved) for thermocouple plunge bath excitation were calculated. The results are shown in Table 2.3.

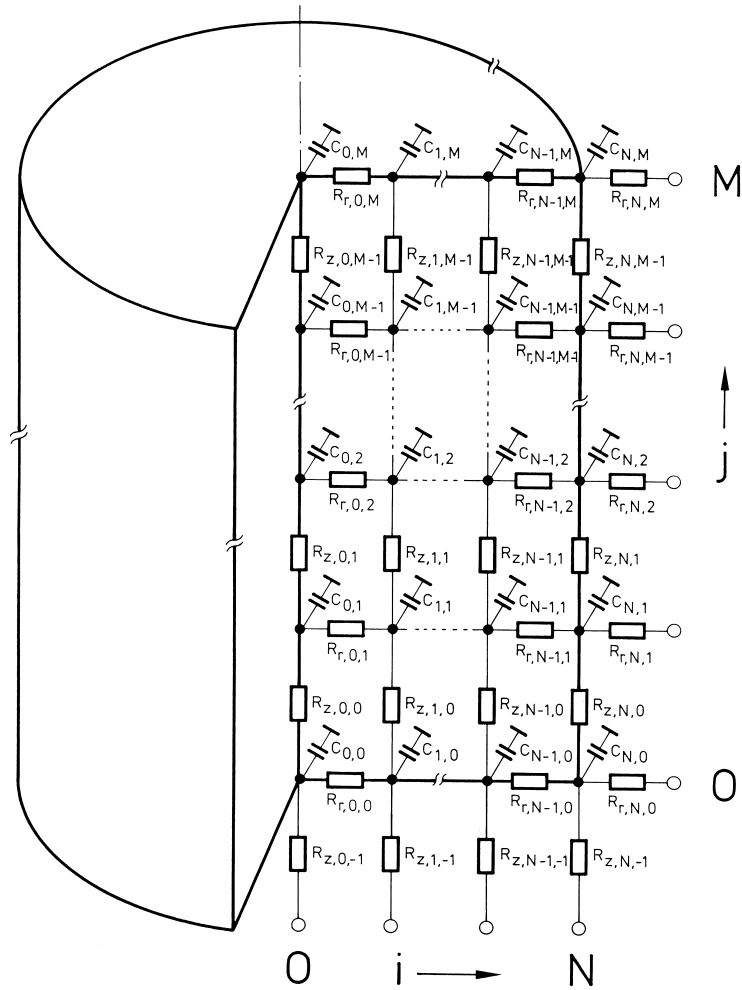

Fig. 2.1. Representation of the sheathed thermocouple as an analogous electrical network.

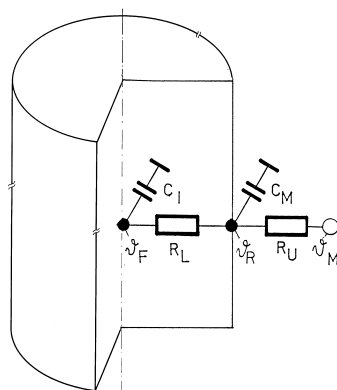

Fig. 2.2. Reduced 2nd order model of the thermocouple.

Table 2.3. Response times in seconds of NiCr-Ni sheathed thermocouples for the plunge bath excitation (from a simulation calculation of 567th order)

Medium	Speed, m/s	Value time, %	Grounding	Diameter, mm							
				0.25	0.5	1.0	1.5	2.0	3.0	4.5	6.0
Water	0.4	50	Grounded	0.007	0.022	0.070	0.143	0.24	0.49	1.00	1.69
			Isolated	0.009	0.031	0.106	0.227	0.39	0.83	1.77	3.05
		90	Grounded	0.018	0.058	0.193	0.396	0.66	1.40	2.95	5.05
			Isolated	0.021	0.070	0.235	0.505	0.86	1.80	3.80	6.46
	0.2	50	Grounded	0.008	0.026	0.084	0.169	0.28	0.57	1.16	1.94
			Isolated	0.011	0.036	0.123	0.256	0.43	0.89	1.93	3.31
		90	Grounded	0.023	0.071	0.232	0.446	0.76	1.58	3.30	5.59
			Isolated	0.027	0.085	0.275	0.575	0.96	2.01	4.27	7.23
Air	2	50	Grounded	0.41	1.18	3.38	6.26	9.7	17.9	33	51
			Isolated	0.42	1.21	3.50	6.43	10.0	18.4	34	53
		90	Grounded	1.35	3.92	11.4	21.1	32.9	60.4	111	173
			Isolated	1.36	3.96	11.7	21.4	33.3	61.9	114	176
	1	50	Grounded	0.55	1.62	4.68	8.73	13.5	25.0	46	71
			Isolated	0.56	1.65	4.82	8.90	13.9	25.6	47	73
		90	Grounded	1.82	5.42	15.7	29.1	45.6	84.0	156	244
			Isolated	1.84	5.46	16.0	29.4	46.1	85.5	159	248

3. EXPERIMENTAL DETERMINATION OF THE TIME BEHAVIOUR OF THE THERMOCOUPLE BY STIMULATION

3.1. Measuring system

The sheathed thermocouple is stimulated with a test function (calibration signal) to achieve a process-coupled determination of the heat transfer function. An electrical heating current is sent through the thermocouple to provide this test function. For this internal electrical stimulation, two effects have been used:

- heating by the Joule effect; the thermal shanks become heated by the friction losses of electrons;
- heating or cooling by the Peltier effect; according to the direction of the current, the junction (soldering joint) of both thermal shanks is heated or cooled; this is the reverse of the Seebeck effect.

For the stimulation, the sheathed thermocouple is connected with a power amplifier. To allow a measurement of the thermovoltage, the power amplifier is separated for a short time and the sheathed thermocouple is switched to the measurement amplifier (Fig. 3.1).

For the Joule stimulation, the heater voltage has to be bipolar for the suppression of the Peltier voltage. Also a special measure for the suppression of the Ettinghausen–Nernst voltage is necessary (Fig. 3.2).

For Joule and Peltier stimulations, the axial transmission of heat is different. Hence, the values of heat capacities and thermal resistances are different according to the stimulation type. However, for plunge bath stimulation and Joule stimulation the material parameters are about identical.

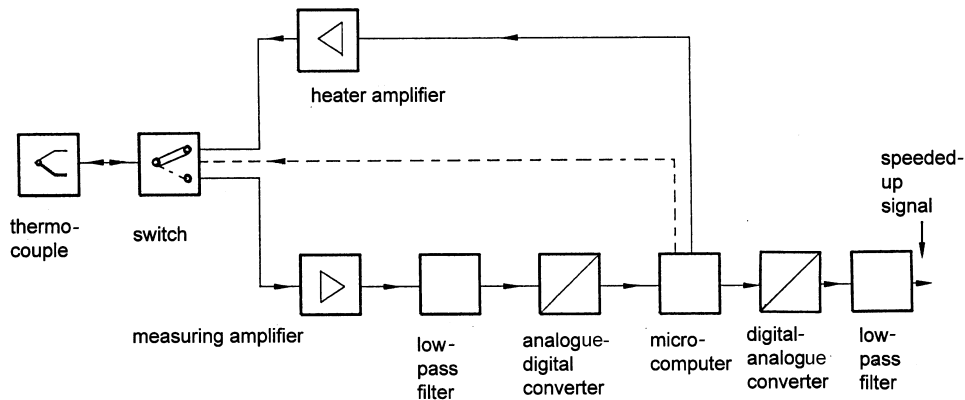

Fig. 3.1. Measuring system for the internal electrical stimulation.

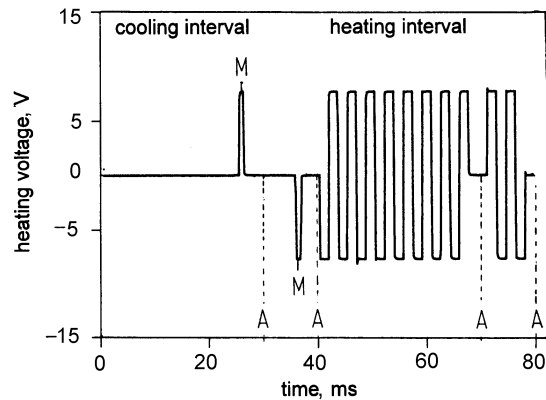

Fig. 3.2. Heater voltage for the Joule stimulation. The voltage is bipolar for the suppression of the Peltier voltage; M is the pulse for suppression of the Ettinghausen–Nernst voltage, A are the sampling points for temperature measurements.

The model of the 2nd order allows a simple conversion of the time behaviour, which was obtained with a Joule stimulation signal, into the operation mode plunge bath. The latter is the more interesting mode as in all applications the thermocouples are stimulated from the outside. With Joule stimulation, the transfer function between external and internal stimulation can be directly calculated from the equivalent network.

3.2. Equivalent network for plunge bath operation (forward operation)

At first the plunge bath operation is investigated. The temperatures of the medium ϑ_M and the soldering joint ϑ_F are to be calculated. These become voltages in the equivalent circuit of Fig. 3.3, which corresponds to Fig. 2.2. The temperature of the medium is an impressed voltage.

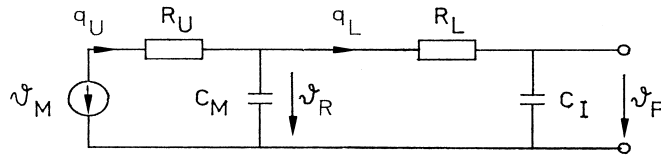

Fig. 3.3. Equivalent network for the 2nd order model of a sheathed thermocouple for plunge bath operation (forward-operation).

3.3. Equivalent network for Joule and Peltier stimulations (reverse operation)

The circuit (Fig. 3.4) is almost identical with that of the forward operation. Only a heat source appears as an additional component for Joule or Peltier stimulations. In the equivalent electric network it is modelled by an impressed current. While computing the time behaviour, only temperature changes are of interest, the temperature of the medium was for simplification considered to remain constant during the reverse operation.

3.4. Comparison of the results

The results of the three stimulations are compared in Fig. 3.5. The thermocouple reaction is the fastest with Peltier stimulation and the slowest with the plunge bath.

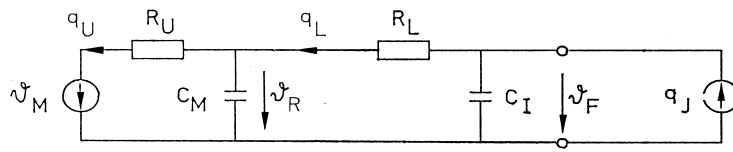

Fig. 3.4. Equivalent network of the 2nd order model of a sheathed thermocouple for Joule and Peltier stimulations.

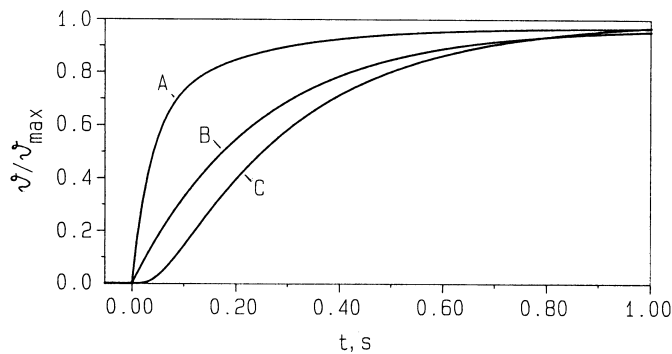

Fig. 3.5. Comparison of the step responses with isolated 1 mm NiCr-Ni sheathed thermocouples: A – Peltier step, B – Joule step, C – plunge bath step.

4. SPEEDUP OF THE TIME BEHAVIOUR

The speedup, the dynamic correction, improves the dynamic behaviour of the sensors. The correction has a high-pass filtering effect. Very important for the exact correction is precise knowledge of the thermocouple time behaviour. As the time constant changes with the operational conditions, the on-line identification becomes necessary. As an example, a first order correction shall be considered. The temperature sensor has the transfer function

$$H(p) = \frac{X_a(p)}{X_e(p)} = \frac{1}{1 + pT}, \quad (4.1)$$

where $X_e(p)$ and $X_a(p)$ are Laplace transforms of the input and output signals and T is time constant.

The correction circuit must have the following inverse transfer function:

$$H^{-1}(p) = 1 + pT. \quad (4.2)$$

This corresponds in the time domain to the correction equation

$$x_e(t) = x_a(t) + T \dot{x}_a(t). \quad (4.3)$$

Figure 4.1 shows the result of a first order time correction. The time constant was on-line determined by the Joule stimulation. The stimulating heating signal depends on time as shown in Fig. 3.2.

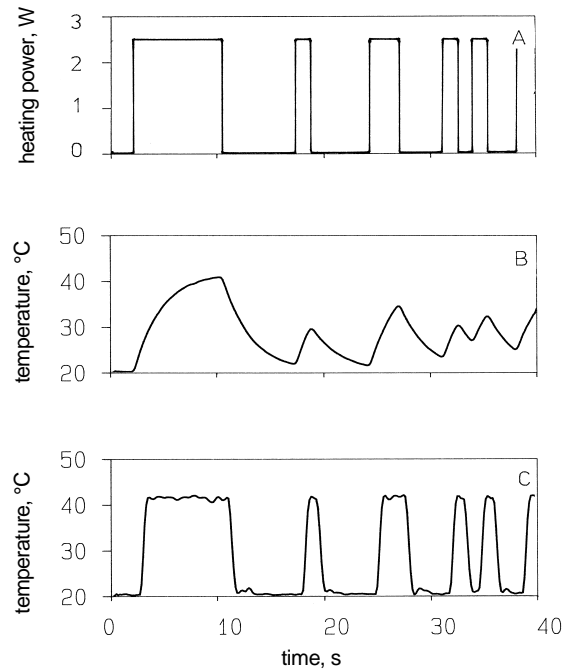

Fig. 4.1. Time correction of a 0.5 mm NiCr-Ni sheathed thermocouple in air with 2 m/s: A – heating signal, B – uncorrected temperature, C – corrected temperature.

In another application, Braun [6] measured with the same arrangement quickly varying temperatures in helicopter gas turbines (Fig. 4.2). Due to the correction, the thermocouple noise is a little higher, but the real temperature values are indicated.

A simple time correction without great circuit expenditure can be carried out by the use of two sheathed thermocouples of different diameters if both temperature sensors have a time behaviour of the first order. Then the ratio of the time constants remains unchanged. The correction, with a time delay, can be carried out very easily (Fig. 4.3).

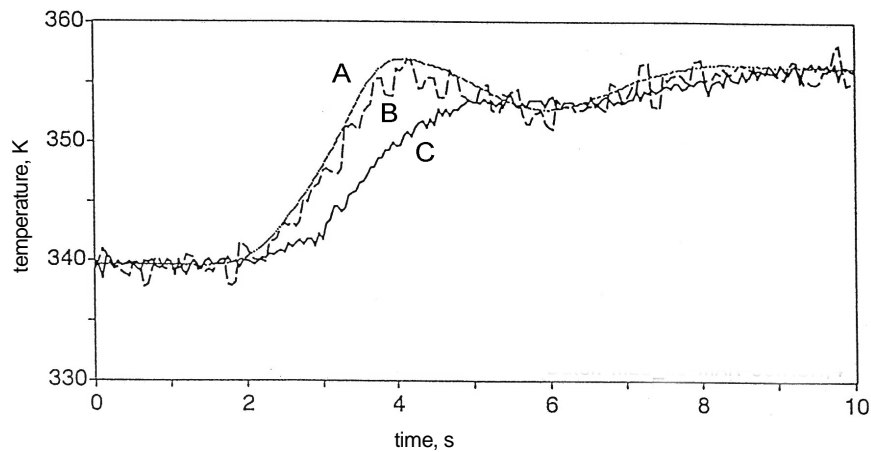

Fig. 4.2. Time correction of the temperature signal in a helicopter turbine, from [6]: A – reference sheathed thermocouple (0.25 mm), B – speeded-up sheathed thermocouple (1.5 mm), C – original signal of sheathed thermocouple (1.5 mm).

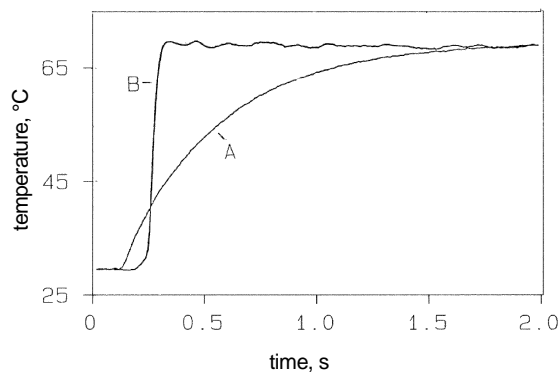

Fig. 4.3. Time correction with a circuit with 2 grounded NiCr-Ni sheathed thermocouples with 0.25 and 0.5 mm of diameter in air with 4 m/s speed: A – uncorrected signal, B – corrected signal.

5. EXPERIMENTAL DETERMINATION OF THE TIME BEHAVIOUR OF THE THERMOCOUPLE BY NOISE SIGNALS

The thermocouple time behaviour can be determined by the methods, mentioned in Chapter 3. But there are still other possibilities to characterize it. A successful method is to analyse the thermocouple noise signal. In the medium, surrounding the sheathed thermocouple, always small stochastic temperature variations are present. These temperature variations can be used for the determination of the time constant. Thus the expenditure for the internal electrical stimulation (heating amplifier, change-over between heating and measuring) becomes unnecessary. In addition, the conversion of the time constants, obtained from internal stimulation, into time constants for external stimulation is also not necessary.

The stochastic temperature variations can be characterized by the time signal, by spectrum and by the density function of the amplitude distribution.

The measuring equipment for stochastic stimulation differs from that of internal electric stimulation. Instead of the heating amplifier and switch sub-assembly, a second measuring channel is used (Fig. 5.1). The second channel allows the reduction of the influence of the amplifier noise by cross-correlation of both channels as the noise voltages of both amplifiers are uncorrelated. The cross-correlation is useful especially for thicker sheathed thermocouples, which deliver weaker noise signals.

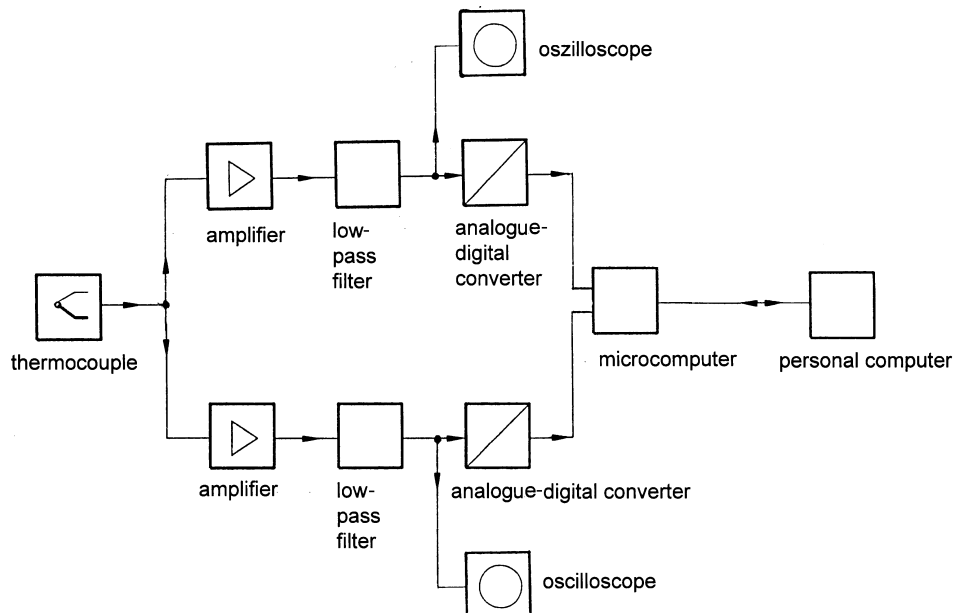

Fig. 5.1. Block diagram for the time constant determination with stochastic stimulation by the medium.

Figure 5.2 shows the time signals of a 0.25 mm sheathed thermocouple in water with 0.2 m/s flow speed and in air with 2 m/s flow speed. For comparison, the signal of the amplifier is also shown with shortened input. All signals were high-pass filtered with a frequency of 0.3 Hz. This was necessary in order to suppress the steady value of the temperature signal (stationary ambient temperature) and the relatively high low-frequency temperature variations in air. These signal components would completely override the highly sensitive measurement amplifier (measuring range 1 mV). In air, the temperature differences and the stimulation amplitudes are considerably higher than in water. The signal is of substantially lower frequency. The transmission of heat in water is better than in air. Therefore the temperature differences are more balanced in water and the signal is smaller.

In order to get quantitative information about the time behaviour from the time signal, the spectrum of the time signal is necessary. It can be determined by means of the Fourier transform. The results are good for time-invariant spectra. For example, Fig. 5.3 shows the corresponding spectra of the time signals of Fig. 5.2. The difference of the spectra is evident.

The stimulation signals can also be classified with the help of the density function of the amplitude distribution. Figure 5.4 shows the density function, standardized on the maximum of the amplitude distribution for the time signals

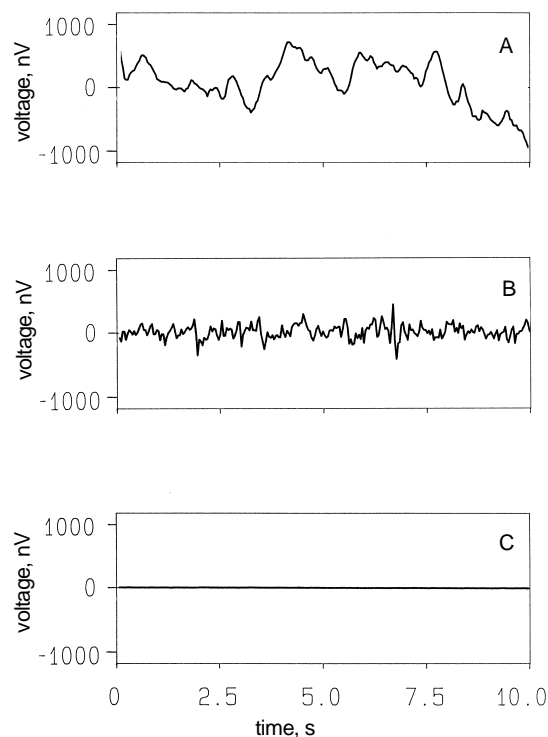

Fig. 5.2. Stochastic signal of isolated 0.25 mm NiCr-Ni-sheathed thermocouples: A – air, flow speed 2 m/s; B – water, flow speed 0.2 m/s; C – short-circuited amplifiers.

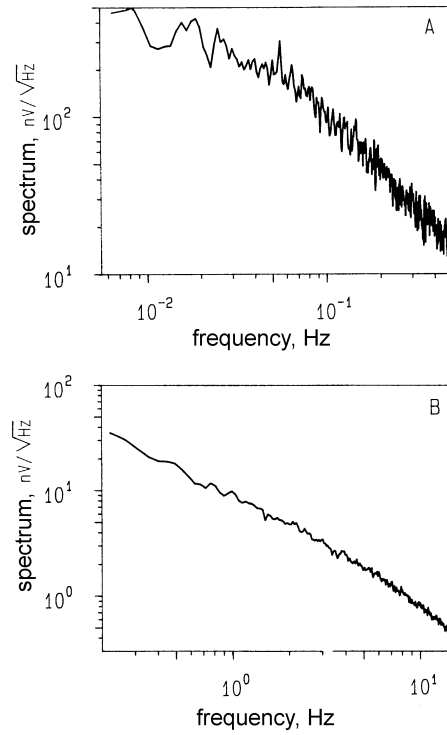

Fig. 5.3. Normalized spectra of an isolated NiCr-Ni-sheathed thermocouple: A – air, flow speed 2 m/s; B – water, flow speed 0.2 m/s.

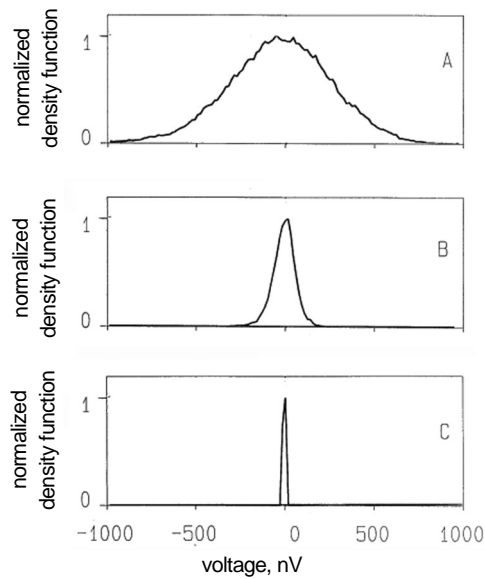

Fig. 5.4. Density function of the amplitude distribution of an isolated 0.25 mm NiCr-Ni sheathed thermocouple: A – air, flow speed 2 m/s; B – water, flow speed 0.2 m/s; C – short-circuited amplifier.

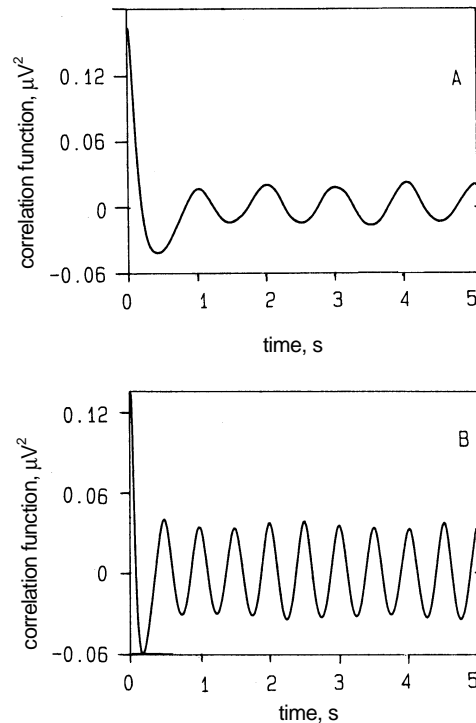

Fig. 5.5. Autocorrelation function of an isolated 0.25 mm NiCr-Ni sheathed thermocouple in circulating water with circulating frequency 1 Hz (A) and 2 Hz (B).

of Fig. 5.2. The density function for the noise in air is quite different from that in water.

From the measured temperature variations even the circulating frequency can be determined. For this purpose the autocorrelation function of the measured signals has to be calculated. Figure 5.5 shows the result. Further examples for thermocouple noise analysis can be found in [7-9].

6. PROCESS SUPERVISION

As discussed before, the heat transfer coefficient determines mostly the time behaviour of a thin shielded thermocouple. It is a function of the Reynolds and Prandtl numbers. These numbers depend on the thermodynamic properties of the medium, surrounding the thermocouple sensor and can change in a very wide range (Table 2.2). In a similar way the time constant of the temperature sensor changes. That means that a detailed analysis of the time behaviour will give information about the medium to be measured. It can be found out whether it is gaseous or liquid, whether it is moving or not and whether there is vapour or water present. Such an information can be very important, e.g., in case of unscheduled operational conditions in industrial plants with accidents or unexpected transients.

Even under extreme conditions, when other sensors have already failed, thermocouples will still be working. They are very reliable sensors.

Information about the medium can be extracted either from the determination of the thermocouple time constant or from noise analysis. By performing it, the thermocouple signal shows not only the temperature, but also the plant conditions. For such a process supervision it is recommended to measure and to store the noise signals already during the regular plant operation. If then an accident occurs, the data, obtained during the correct operation, can be compared with the data, obtained during or after the accident. The comparison will show whether or not the thermodynamic properties of the process have changed. Such an information can be obtained not only by shielded thermocouples, but by all temperature sensors with very low time constants. However, this is only possible, if an intelligent signal analysis is available.

REFERENCES

1. Sarnes, B. *Prozessgekoppelte Bestimmung und dynamische Korrektur des Zeitverhaltens von Mantelthermoelementen*. PhD. Thesis, Technische Universität München, 1988.
2. D'Ans, J. and Lax, E. *Taschenbuch für Chemiker und Physiker*. Springer, Berlin, 1967.
3. Holman, J. P. *Heat Transfer*. Mc Graw Hill, Auckland, 1981.
4. Koch, B. *Grundlagen des Wärmetausches*. Verlag H. Beucke u. Söhne, Dissen, 1950.
5. Landolt H. H. and Börnstein, R. *Zahlenwerte und Funktionen aus der Physik, Chemie, Astronomie, Geophysik und Technik* (6. Auflage, Bd. IV/2a, 3, 4a, 4b), Springer, Berlin, 1972.
6. Braun, H. *Experimentelle Untersuchungen zur dynamischen Druck- und Temperaturmessung in einer Hubschrauber-Gasturbine*. PhD Thesis, Technische Universität München, 1992.
7. Bergdahl, B. G. and Osuma, R. Health test of components in nuclear reactor instrument systems using process identification. In *OECD Nuclear Energy Agency Symposium on Reactor Noise*. Munich, 1987, 593–604.
8. Girard, J. P., Recroix, H., Beesley, M. J., Weinkoetz, G., Krebs, L., Overton, R. S. and Hughes, G. Detection of coolant temperature noise in SPX1 using intrinsic high frequency thermocouples. In *OECD Nuclear Energy Agency Symposium on Reactor Noise*, Munich, 1987, 377–392.
9. Iida, S. Instrumentation method and analysis of small temperature fluctuation in incore coolant. In *OECD Nuclear Energy Agency Symposium on Reactor Noise*, Munich, 1987, 575–580.

Termopaaride ajalise käitumise määramine termosensorite reaktsiooni kiirendamiseks nende kasutamiseks keskkonnaaatlustes

Bernhard Sarnes ja Elmar Schrüfer

Termopaaire saab kasutada nii kohaliku temperatuuri mõõtmiseks kui ka ümbritseva mõõtekeskkonna jälgimiseks. Mõlema juhu jaoks on vaja teada termopaaari reaktsioonikiirust, mis avaldub ajakonstandi kaudu. Kuna aga ajakonstant sõltub keskkonna parameetritest, siis tuleb teha *in situ* kalibreerimisi. On käsitletud selle probleemi lahendamist testide ja modelleerimise abil.